

**YUSHIN**

Annual Report

**2019**

Year Ended March 31, 2019

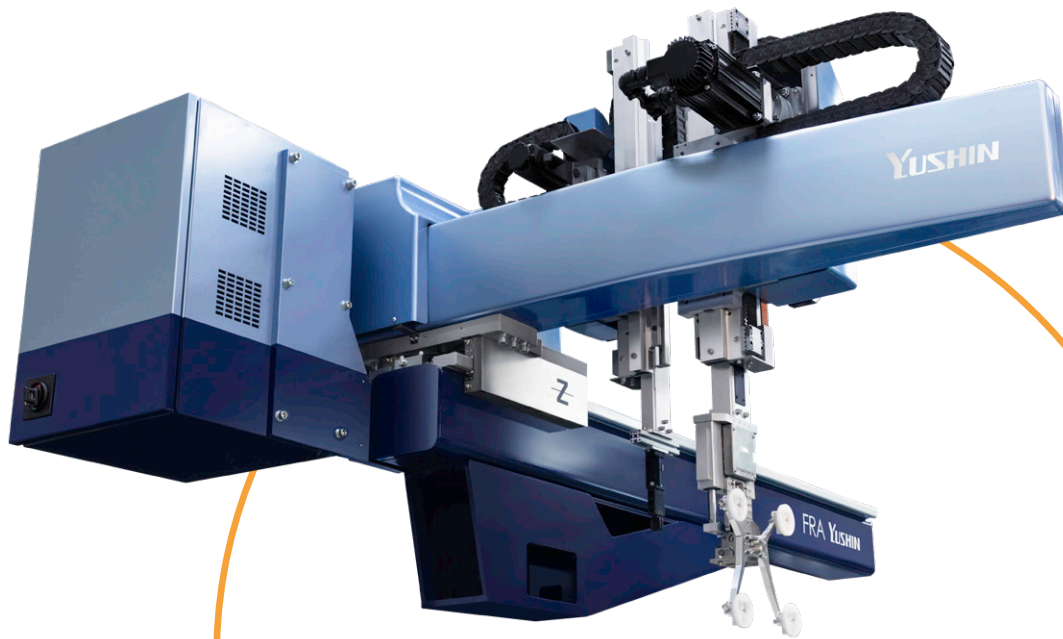

**INTU  
LINE**



**YUSHIN PRECISION EQUIPMENT CO., LTD.**

Securities Identification Code : 6482

# Outline of YUSHIN PRECISION EQUIPMENT

Our name "YUSHIN", means to be both conscientious and trustworthy in Japanese. As these terms suggest, our goal is to be a company that earns and deserves the trust of customers. This is why we work constantly to develop products and systems based on what we call "Heartful Technology", that reaches heart to heart.

Since 1973, we have been striving to make the molding process more efficient, focusing on the development and manufacturing of Take-out robots for plastic injection molding products. To us, the words "impossible" or "it can't be done" mark the starting point of a challenge.

To be successful, we must continue to introduce innovative products, for instance, ultra-high speed robots and factory automation systems for bringing new capabilities into the customers.

As an innovator in the plastic molding process, YUSHIN intends to continue developing equipment that will improve quality, and simplify the molding new types of products. Taking advance with automation for plastic molding plants, YUSHIN has been expanding its service network throughout the world.

YUSHIN also conducts its business so as to live up to the trust and expectations of its customers, shareholders, suppliers, employees, local communities and all other stakeholders.

できない事、理だ、は出発点  
Impossible mark the starting point of a challenge.



Susumu Kotani, YUSHIN's Founder



— Serving society through developing plastics industry —

# Message from the President

**Through the ongoing creation of innovative technology, we make a far-reaching contribution to society on a global scale.**



"Attempting the impossible is the starting point for all new technology" is the motto that YUSHIN PRECISION EQUIPMENT adheres to, based on our founder - Susumu Kotani's philosophy. Following this philosophy has led the company to consistently develop innovative technologies at the forefront of global industry.

Now, YUSHIN sets its medium-term management goal of sales of 30 billion yen and ordinary income of 5 billion yen or more.

YUSHIN aims to develop further as a leading company in the Take-out robot industry, developing products rapidly to meet the diversified and sophisticated needs of our customers.

We would appreciate for your continued support.

August 2019

*Mayumi Kotani*  
 Mayumi Kotani  
 President and  
 Representative Director

# Consolidated Financial Highlights

YUSHIN PRECISION EQUIPMENT CO., LTD. and Subsidiaries  
 Years Ended March 31

	Millions of Yen					Thousands of U.S. Dollars
	2019	2018	2017	2016	2015	2019
<b>For the year:</b>						
Net sales	¥ 21,833	¥ 20,878	¥ 19,346	¥ 21,148	¥ 17,799	\$ 196,697
Operating income	2,760	2,358	2,112	3,086	2,304	24,872
Income before income taxes	2,783	2,438	2,009	2,858	2,566	25,077
Net income attributable to owners of the parent	1,903	1,626	1,380	1,908	1,683	17,148
R&D Expenses	413	598	619	510	472	3,722
<b>At Year end:</b>						
Total assets	33,197	32,572	30,761	29,409	29,463	299,074
Equity	27,117	26,472	25,451	24,715	23,970	244,301
<b>Per share of common stock:</b>						
	Yen					U.S. Dollars
Net income	¥ 54.54	¥ 46.51	¥ 39.46	¥ 54.57	¥ 48.13	\$ 0.49
Cash dividends	17.00	33.00	36.00	36.00	30.00	0.15
Equity	783.03	750.37	722.19	700.77	678.68	
<b>Equity ratio:</b>						
	%					
Return on assets	5.8 %	5.1 %	4.6 %	6.5 %	6.0 %	
Return on equity	7.2	6.3	5.6	7.9	7.4	

Notes: The computation of net income per share is based on the weighted average number of shares of common stock outstanding during each year, retroactively adjusted for stock splits, including those stock splits made after year-end.  
 Cash dividends per share are dividends applicable to the respective years including dividends to be paid after the end of the year.  
 The computation of equity per share is based on the number of shares of common stock outstanding each end of year, retroactively adjusted for stock splits, including those stock splits made after year-end.  
 Translations of Japanese Yen amounts into U.S. dollar amounts are made at the rate of ¥111 to \$1.

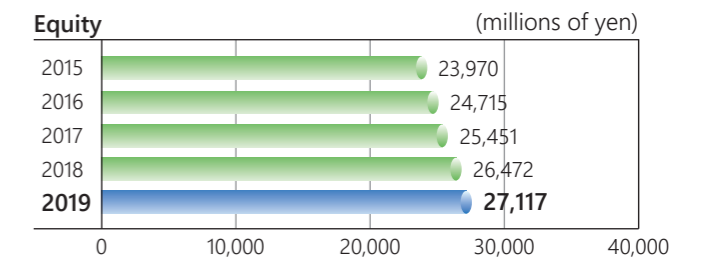
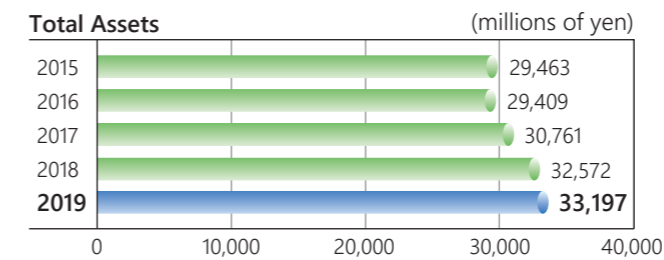
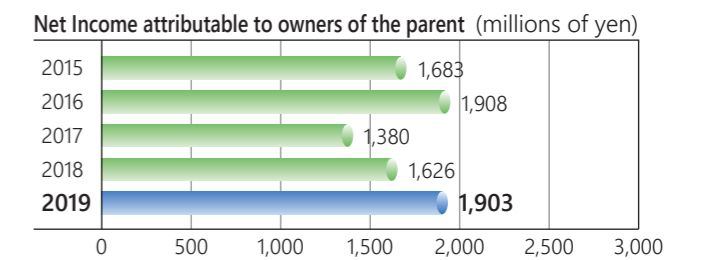
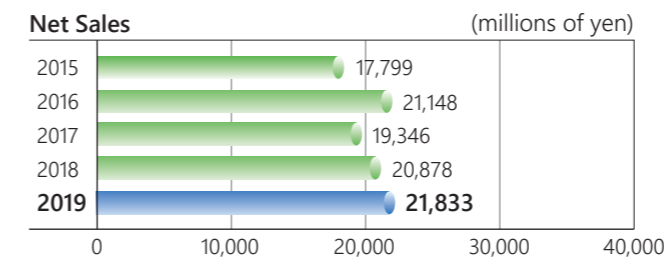

### Estimates, Forecasts, and Plans

The performance estimates, forecasts of the business environment, and business plans contained in this publication are based on the information available at the time of compilation. Statements herein regarding these performance estimates, forecasts of the business environment, and business plans may contain inaccurate elements. In addition, there is a possibility of unknown risks, uncertainties, and contingencies emerging that may invalidate these performance estimates, forecasts of the business environment, and business plans. As a result, the reader is requested to understand that actual results / performance, the business environment and business plans in the future may differ materially from the content of this publication.

# Financial Review

YUSHIN PRECISION EQUIPMENT CO., LTD. and Subsidiaries  
Year ended March 31, 2019

## 1. Net Sales

Net sales increased by 4.6% year on year to a record high of 21,833 million yen.

The main reason for the increase in sales is that sales in the Custom-ordered Equipment increased by 30.6% from the previous fiscal year. In Japan, sales remained strong on the background of automation needs, and overseas sales increased mainly for medical products.

Sales of Take-out Robots increased by 0.4% from the previous fiscal year due to strong sales in Japan, North America, etc. despite the slowing in China.

By end user categories, sales to automotive and medical products were strong. On the other hand, electronic parts and optical instruments sales were sluggish mainly in countries such as China and Korea.

## 2. Operating Income

Operating income increased by 17.0% year on year to 2,760 million yen, owing to reductions in depreciation expenses and normalization of development costs that was concentrated to new product development etc. although there was purchase price increase due to difficulties in procuring parts in the first half.

## 3. Financial Condition

### <Assets>

Total assets increased by 624 million yen from the end of the previous fiscal year to 33,197 million yen. This was mainly due to increase of 707 million yen in Cash and deposits.

### <Liabilities>

Total liabilities decreased by 21 million yen from the end of the previous fiscal year to 6,079 million yen.

### <Net assets>

Net assets increased by 645 million yen from the end of the previous fiscal year to 27,117 million yen due to increase of Retained earnings by 1,308 million yen.

## 4. Cash Flow

The balance of cash and cash equivalents on March 31, 2019 increased by 905 million yen from the end of the previous fiscal year to 4,669 million yen. Main reasons are as follows.

### <Cash flow from operating activities>

Income before income taxes was 2,783 million yen. After deducting 933 million yen in Income taxes paid, cash flow from operating activities for the fiscal year ended March 31, 2019 was a net inflow of 2,291 million yen (it was a net inflow of 1,223 million yen in the previous fiscal year).

### <Cash flow from investment activities>

Due to Purchase of property, plant and equipment by 193 million yen, cash flow from investment activities for the fiscal year ended March 31, 2019 was a net outflow of 61 million yen (it was a net outflow of 2,511 million yen in the previous fiscal year).

### <Cash flow from financing activities>

Due to Purchase of treasury stock by 684 million yen and Cash dividends paid of 594 million yen, cash flow from financing activities for the fiscal year ended March 31, 2019 was a net outflow of 1,316 million yen (it was a net outflow of 659 million yen in the previous fiscal year).

## 5. Shareholder Returns

Regarding policy on shareholder returns, our basic policy is to pay dividends, taking into consideration business results, company conditions and internal reserves. We have set a target payout ratio of at least 30% of consolidated net income. In the FY2019, we paid an annual dividend of 17 yen per share, with a payout ratio of 30.9%.

In addition, in February 2019, we decided to execute a share repurchase of common stock (up to 1 million shares, up to 1 billion yen). This is intended to improve capital efficiency, enhance shareholder returns, and implement flexible capital policies.

# Review of Operations

## Take-out Robots

Net sales of Take-out Robots increased by 62 million yen (0.4%) from the previous FY to 15,512 million yen.

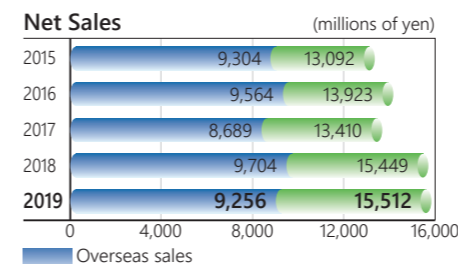
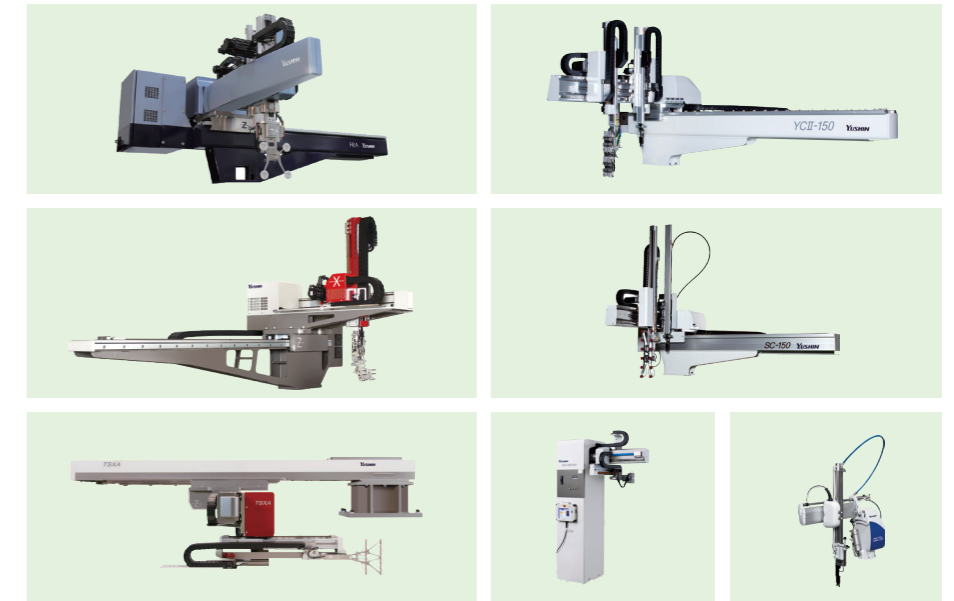

## Custom-ordered Equipment

Net sales of Custom-ordered Equipment increased by 675 million yen (30.6%) from the previous FY to 2,880 million yen.

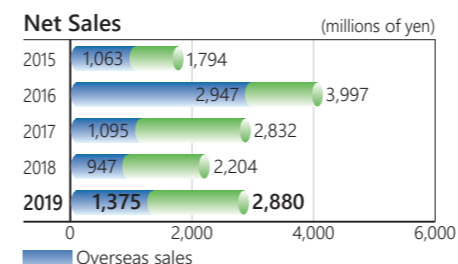

## Parts and Maintenance Service

Net sales of Parts and Maintenance Service increased by 216 million yen (6.7%) from the previous FY to 3,440 million yen.

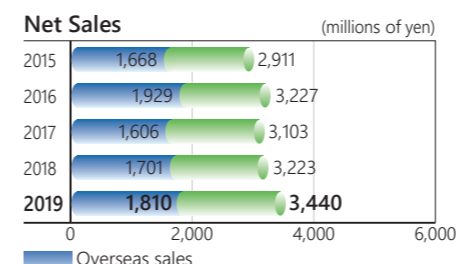

## Sales Composition by Products

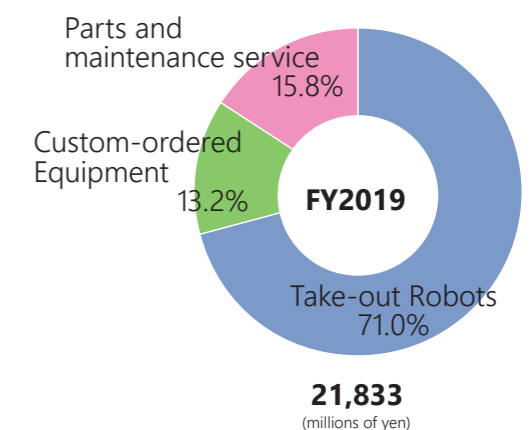



## Outlook for Fiscal Year 2020

Regarding the future global economy, uncertainty is increasing, because there are many uncertain factors such as trade friction between United States and China and political instability in Europe.

The forecast for the current fiscal year ending March 2020 is as follows.

(Millions of yen)

	Consolidated
Net sales	22,000 (Y/Y 0.8%)
Operating income	2,800 (Y/Y 1.4%)
Net income attributable to shareholders of the parent	1,950 (Y/Y 2.4%)

Under these circumstances, YUSHIN Group will strive to expand sales of differentiated Take-out Robots and improve brand value. In addition, by establishing a European subsidiary, we will expand sales channels and expand our service in Europe. In Custom-ordered Equipment business, we will continue to expand sales and develop new businesses to meet the growing automation needs in and outside Japan. Furthermore, we will strengthen collaboration among divisions to improve productivity, work styles, and accelerate cost reduction activities.

### Performance of Geographic Segments

#### <Japan>

Net sales increased by 4.5% from the previous FY to 17,474 million yen and operating income increased by 45.2% from the previous FY to 2,045 million yen.

#### <North America>

Net sales increased by 7.5% from the previous FY to 3,441 million yen and operating income increased by 17.9% from the previous FY to 307 million yen.

#### <Asia>

Net sales decreased by 7.0% from the previous FY to 5,200 million yen and operating income decreased by 12.3% from the previous FY to 533 million yen.

#### <Europe>

Net sales increased by 31.4% from the previous FY to 917 million yen and operating income decreased by 37.4% from the previous FY to 81 million yen.

### Overseas Sales

Overseas sales simply indicate YUSHIN's world sales to countries and areas other than Japan. Overseas sales decreased by 0.1% year on year to 12,528 million yen from the previous fiscal year. And the ratio of overseas sales to the total net sales was 57.4%.

### Sales Composition by Region

(millions of yen)

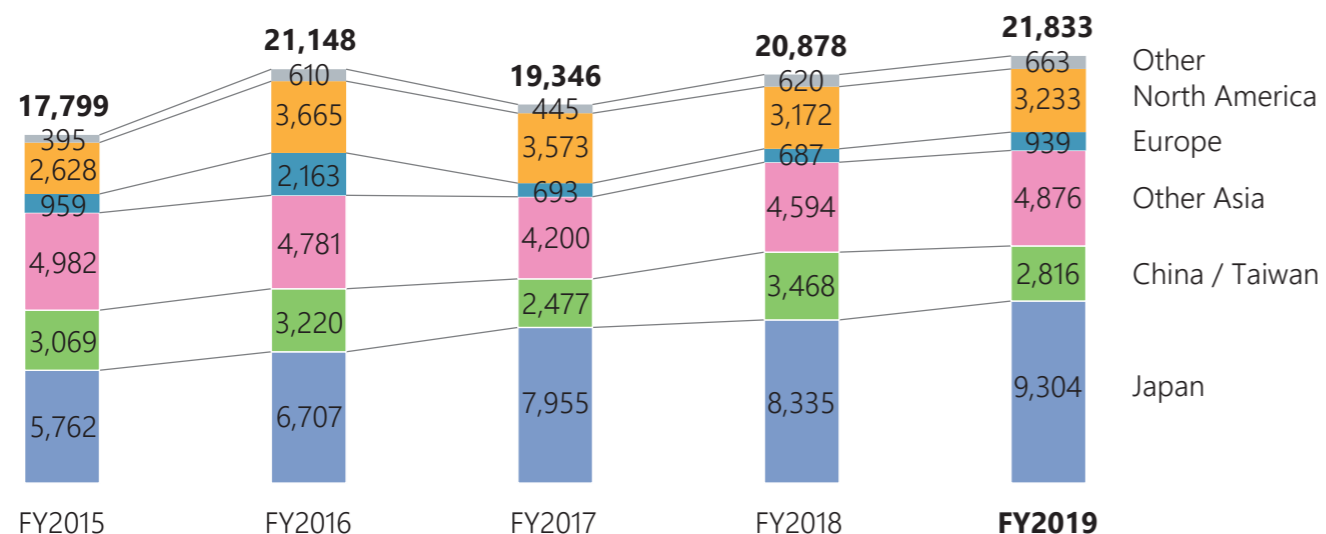

## Medium and Long-Term Management Strategies

YUSHIN has set the medium-term management targets of net sales of 30 billion yen and ordinary income of 5 billion yen or more.

#### <Company strategy>

YUSHIN strengthens and conducts business even more aggressively in the global market, and works on developing superior cost-effective products with its quality and performance to meet our customer needs. And YUSHIN will also attract new customer for the Take-out Robots while promoting receiving orders for Custom-ordered Equipment in a new business area. In addition, YUSHIN continues to improve productivities and promote operational efficiencies utilizing a new headquarters and factory which was opened in December, 2016.

#### <Market strategy>

YUSHIN has developed a sales and service network for Take-out robots in the U.S, Asia, and Europe. YUSHIN will continuously expand and strengthen the network in areas where business is expected to grow to develop a global business that can adequately respond to worldwide customer purchases. Especially, YUSHIN aims to develop new customers in emerging countries where labor costs are highly rising and develop world-class human resources who can sustain for expanding our presence around the world.

#### <Product strategy>

YUSHIN will continuously offer the definitely-differentiated product by appealing the performance superiority such as high-speed motion, vibration suppression and power-saving. In order to establish multiple core businesses, YUSHIN must develop and bring new products to the market in the business area where YUSHIN can manifest technological and/or sales synergies.

# Global Network (As of June, 2019)



Headquarters & Factory



USA



Korea



Malaysia



Taiwan



Thailand



UK



China (Shenzhen)



China (Shanghai)



Vietnam



China (Guangzhou)

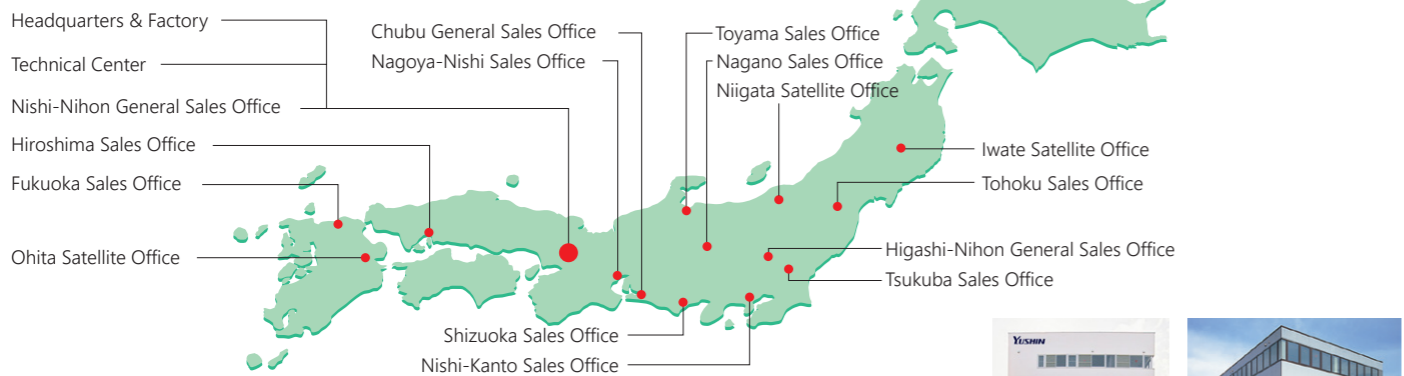
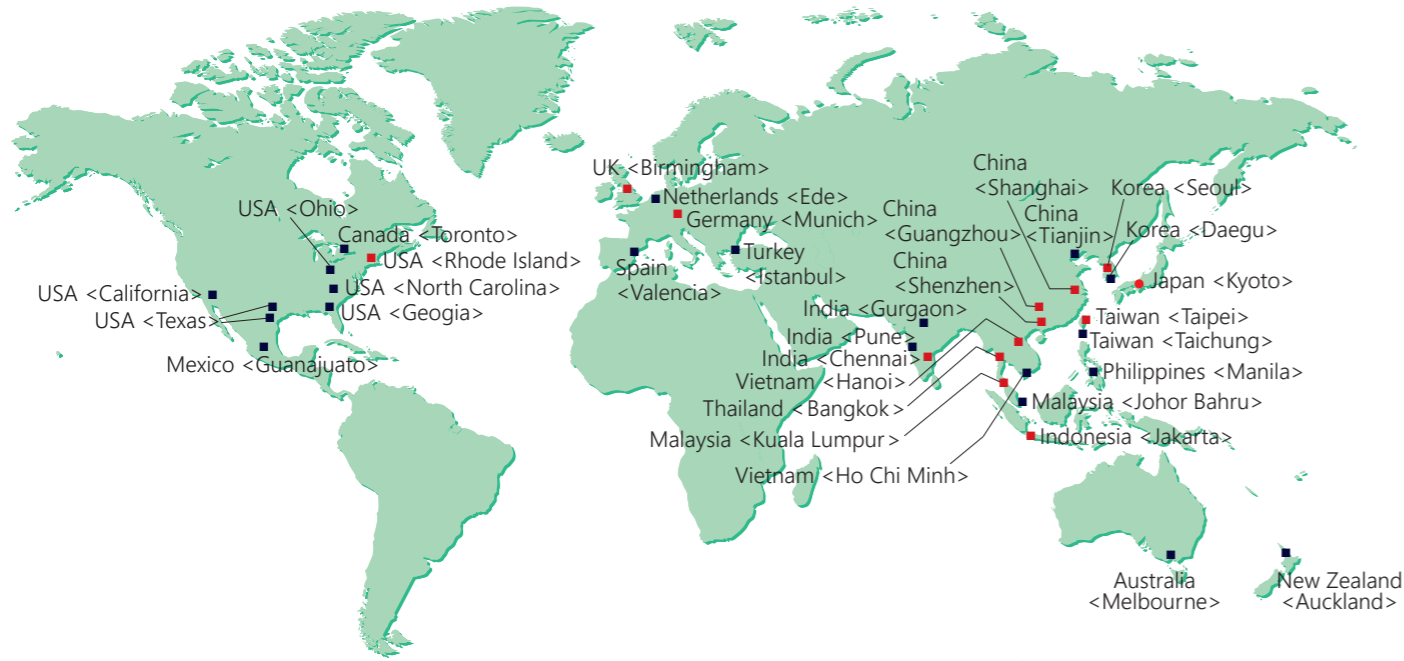

Chubu General Sales Office



Higashi-Nihon General Sales Office

## ● Headquarters & Factory

### YUSHIN PRECISION EQUIPMENT CO., LTD.

555 Kuzetonoshiro-cho, Minami-ku, Kyoto, Japan 612-8205  
TEL: +(81)75-933-9555 FAX: +(81)75-934-4033

## ■ Subsidiaries

### ■ South Korea

■ YUSHIN KOREA CO., LTD.  
TEL: +(82)31-433-9655~6 FAX: +(82)31-433-9663

■ DAEGU BRANCH  
TEL: +(82)53-951-9442 FAX: +(82)53-951-9443

### ■ China

■ YUSHIN PRECISION EQUIPMENT TRADING (SHANGHAI) CO., LTD.  
TEL: +(86)21-6440-1586~7 FAX: +(86)21-6440-1806

■ YUSHIN PRECISION EQUIPMENT TRADING (SHANGHAI) CO., LTD. TIANJIN BRANCH  
TEL: +(86)22-8823-8713 FAX: +(86)22-8823-8517

■ YUSHIN PRECISION EQUIPMENT TRADING (SHENZHEN) CO., LTD.  
TEL: +(86)755-8358-0139 FAX: +(86)755-8358-0159

■ GUANGZHOU YUSHIN PRECISION EQUIPMENT CO., LTD.  
TEL: +(86)20-8269-0091 FAX: +(86)20-8269-0001

### ■ Taiwan

■ YUSHIN PRECISION EQUIPMENT (TAIWAN) CO., LTD.  
TEL: +(886)2-2585-0507 FAX: +(886)2-2585-0527

■ TAICHUNG BRANCH  
TEL: +(886)4-2265-8155 FAX: +(886)4-2265-2602

### ■ Indonesia

■ PT.YUSHIN PRECISION EQUIPMENT INDONESIA  
TEL: +(62)21-8835-8185 FAX: +(62)21-8835-8186

### ■ Vietnam

■ YUSHIN PRECISION EQUIPMENT(VIETNAM) CO., LTD.  
TEL: +(84)243-767-3844 FAX: +(84)243-767-3845

■ YUSHIN PRECISION EQUIPMENT(VIETNAM) CO., LTD. HO CHI MINH REPRESENTATIVE OFFICE  
TEL: +(84)283-899-0662 FAX: +(84)283-899-0648

### ■ Malaysia

■ YUSHIN PRECISION EQUIPMENT SDN. BHD.  
TEL: +(60)3-5880-5445 FAX: +(60)3-5879-3151

■ JOHOR BAHRU BRANCH  
TEL: +(60)7-598-5450 FAX: +(60)7-598-0102

### ■ Thailand

■ YUSHIN PRECISION EQUIPMENT (THAILAND) CO., LTD.  
TEL: +(66)2-662-2580 FAX: +(66)2-662-2583

### ■ India

■ YUSHIN PRECISION EQUIPMENT (INDIA) PVT. LTD.  
TEL: +(91)44-4231-8005 FAX: +(91)44-4231-8006

■ GURGAON BRANCH  
TEL: +(91)124-474-8229 FAX: +(91)124-474-8230

■ PUNE OFFICE

## ● Technical Center

487 Kuzetsukiyama-cho, Minami-ku, Kyoto, Japan 601-8203  
TEL: +(81)75-933-9555 FAX: +(81)75-922-3151

### ■ Germany

■ YUSHIN EUROPE GMBH  
TEL: +49 (0)89-89-796-713 FAX: +49 (0)89-89-743-737

### ■ UK

■ YUSHIN AUTOMATION LIMITED  
TEL: +(44)-1527-558-218 FAX: +(44)-1527-558-219

### ■ U.S.A.

■ YUSHIN AMERICA, INC.  
TEL: +(1)401-463-1800 FAX: +(1)401-463-1820

■ YUSHIN AMERICA, INC. NORTH CAROLINA OFFICE

■ YUSHIN AMERICA, INC. OHIO OFFICE

■ YUSHIN AMERICA, INC. GEORGIA OFFICE

■ YUSHIN AMERICA, INC. TEXAS NORTH OFFICE

■ YUSHIN AMERICA, INC. TEXAS OFFICE

■ YUSHIN AMERICA, INC. CALIFORNIA OFFICE

### (MEXICO)

■ YUSHIN AMERICA, INC. MEXICO BRANCH  
TEL: +(52)477-761-2696 FAX: +(52)477-761-2696

## ■ Representative office

### ■ Philippines

■ YUSHIN PRECISION EQUIPMENT CO., LTD. PHILIPPINES REPRESENTATIVE OFFICE  
TEL: +(63)2-893-7546 FAX: +(63)2-856-9616

## ■ Agent

### ■ New Zealand

■ TASMAN MACHINERY LTD.  
TEL: +(64)9-379-5716 FAX: +(64)9-379-9915

### ■ Australia

■ TASMAN MACHINERY PTY LTD.  
TEL: +(61)3-8587-8200

### ■ Turkey

■ TEKKAN PLASTIK SAN. ve TIC. A.S.  
TEL: +(90)216-593-20-01 FAX: +(90)216-593-00-36

### ■ Netherlands

■ POLYMAC-ROBOTICS B.V.  
TEL: +(31)318-648600 FAX: +(31)318-648610

### ■ Spain

■ OLMAC,S.L.  
TEL: +(34)961-212-772 FAX: +(34)961-212-772

### ■ Canada

■ EN-PLAS, INC.  
TEL: +(1)416-286-3030 FAX: +(1)416-286-5963

## ● Take-out Robot "FRA" Won Many Awards

The new top model of Take-out robot "FRA" received four prominent awards.

I. In March 2019, the "Development of Take-out robot for injection molding machine equipped with an active vibration control device" received an award of "The Japan Society of Mechanical Engineers Medal for New Technology in 2018" awarded by the Japan Society of Mechanical Engineers. The originality and progressiveness of the device were appraised.



High End Take-out Robot - FRA

II. In March 2019, FRA received "Red Dot Award: Product Design 2019". Red Dot Award is recognized as one of the three most prestigious awards in the world.



III. In July 2018, FRA won the "the Japan Robot Industry Association Award in the 48th MACHINE DESIGN AWARD" sponsored by the Nihon Industrial Newspaper and the Ministry of Economy, Trade and Industry. The high performance of the FRA's IoT function, user friendliness, and "active vibration control" that can be expected to improve productivity and product quality were evaluated. In addition, the beautiful design based on the "Design Optimization" was also highly rated.

IV. In January 2019, FRA received "the Japan Machinery Federation's Energy-Efficient Machinery Award. YUSHIN received the award for the second time following Take-out robot YC series. The continuous energy saving efforts of YUSHIN, including "Design Optimization" was evaluated.

## ● German Subsidiary Established

In May 2019, we established a local subsidiary YUSHIN EUROPE GMBH near Munich, Germany, with a 100% stake. There are manufacturing bases for many companies around Munich, and it has good access to Eastern Europe.

YUSHIN has provided services to customers in the European region through local subsidiaries in the United Kingdom and distributors in the Netherlands and Turkey.

In the future, we will use the German subsidiary as a base to control our business in Europe and expand sales channels in the European market. Also, in order to establish the YUSHIN brand in the European market, we will provide high-end customers with high-performance Take-out robots that can differentiate themselves from European manufacturers. In addition, we will expand our technical support system, which has been highly evaluated in other area in the world, to the European market.

## E Environment

### < Environmental Load Reduction >

- Development of energy - saving products (Won the JMF's Energy-Efficient Machinery Award)

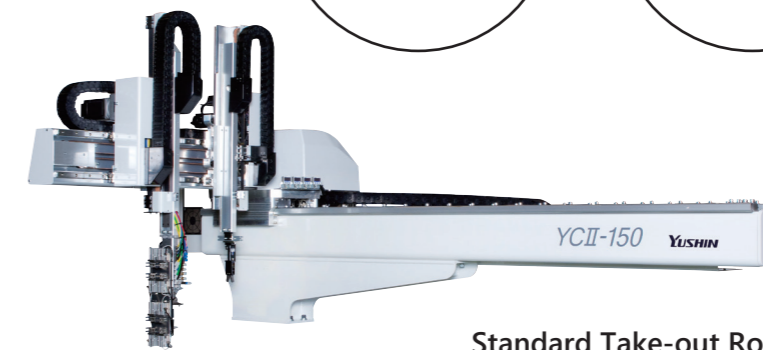
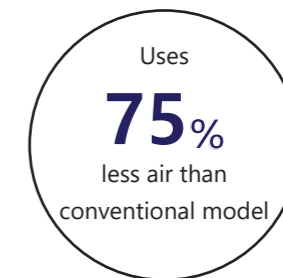
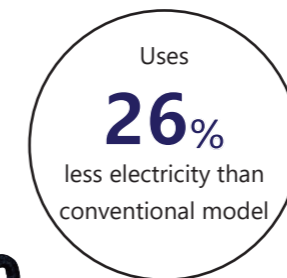

Standard Take-out Robot - YC

- Promotion of environmental management system (ISO14001)

## S Social

### < Working Style Reform of Customer Factories >

- Providing factory automation system

### < Safety and Security >

- Sale of the world's highest safety standard equipped robot

### < Improvement of Working Environment >

- Working style support team  
- System of maternity leave and shorter working hours (more than statutory)

## G Governance

### < Strengthen the Governance System >

- Of the 7 directors, 3 are external directors  
- Improvement of board of directors by effectiveness evaluation

## Related SDGs Items

3 GOOD HEALTH AND WELL-BEING



5 GENDER EQUALITY



7 AFFORDABLE AND CLEAN ENERGY



8 DECENT WORK AND ECONOMIC GROWTH



9 INDUSTRY, INNOVATION AND INFRASTRUCTURE



12 RESPONSIBLE CONSUMPTION AND PRODUCTION



13 CLIMATE ACTION



SUSTAINABLE DEVELOPMENT GOALS

# ESG - Governance

## Basic Views on Corporate Governance

YUSHIN PRECISION EQUIPMENT CO., LTD. (hereinafter referred to as "The Company") aims at achieving sustainable growth and maximizing the enterprise value for medium- and long-term under the management philosophy with obtaining credibility from all stakeholders surrounding YUSHIN including shareholders. We strive to strengthen corporate governance with the basic policy of following five items.

1. The Company respects the rights of shareholders and ensures equality, as well as strives to improve the environment for executing rights appropriately and protect rights.
2. The Company strives to sincerely cooperate with stakeholders excluding our shareholders with good sense.
3. The Company strives to ensure the transparency by appropriately making disclosure according to laws and regulations and voluntarily providing information excluding the disclosure.
4. The Board of Directors strives to execute its roles and duties appropriately for transparent/fair and flexible decision-making.
5. The Company strives to positively communicate with shareholders after sharing the direction of its stable growth for long-term.

## Organization Chart

(As of June, 2019)

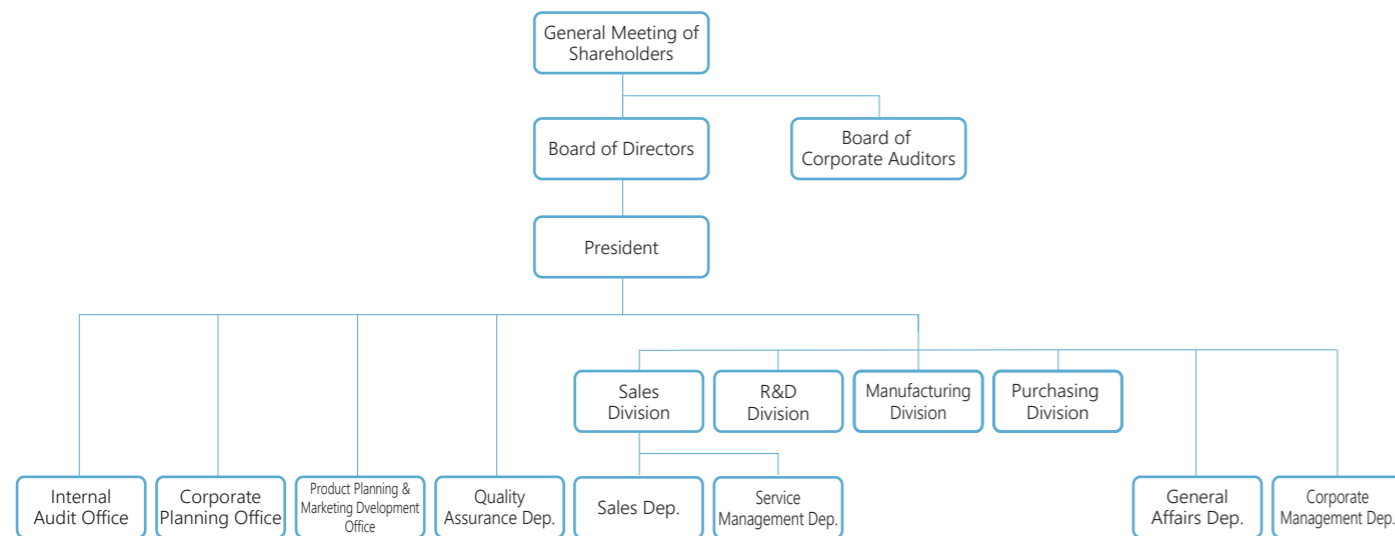

## Progress of Board of Directors

Under rapidly changing business environment and advancement of globalization, the Company appoints candidates of Directors with a focus on balance among knowledge, experience and expertise, diversity and global viewpoints. Now seven Directors, including three External Directors (more than one third of the Board of Directors) and two of them are independent Directors, take office. The Company will keep the number of the board members that immediate decision-making can be conducted with each member providing his or her expertise and exchanging opinions each other.

External Directors now analyze and evaluate whole of the Board of Directors. To further improve the functions of the Board of Directors, analysis and evaluation of effectiveness of the whole Board including their methods are currently examined.

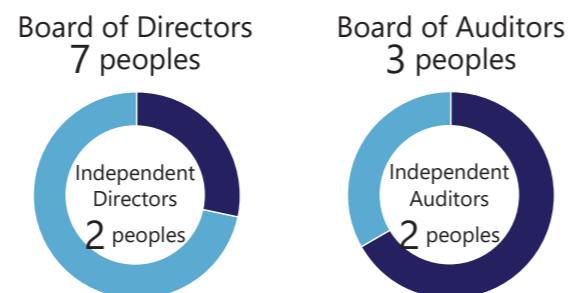

## Chart of Corporate Governance System

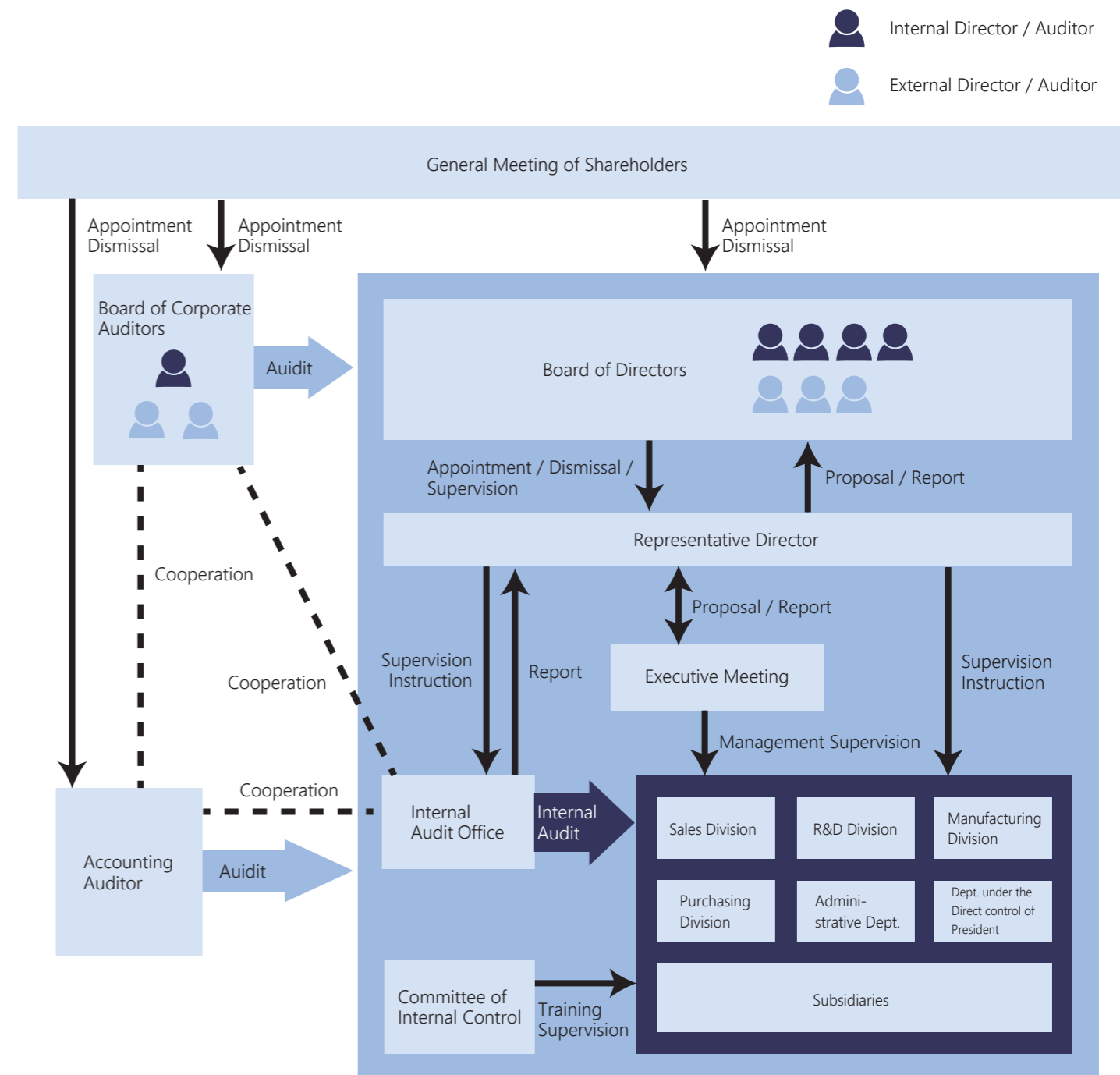



# Board of Directors, Auditors and Officer

As of June 30, 2019

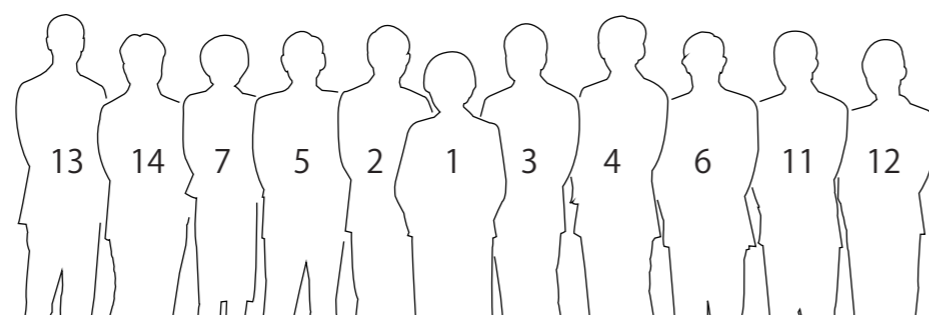

## ● Directors

### 1. Mayumi Kotani

October 1973 Joined the Company  
 October 1982 Director  
 February 1989 Executive Vice President and Director  
 March 1993 Executive Vice President and Director, General Manager of Sales Division  
 December 2002 President and Representative Director  
 April 2006 President and Representative Director and General Manager of Sales Division  
 March 2011 President and Representative Director (To the present)

### 2. Satoshi Kimura

April 2005 Joined the Company as Executive Officer and General Manager of Purchase Dept.  
 October 2005 Executive Officer and General Manager of Purchase Dept.  
 April 2006 Senior Executive Officer and General Manager of Purchasing Division  
 June 2006 Managing Director and General Manager of Purchasing Division  
 June 2008 Executive Managing Director and Managing Director of Purchasing Division (To the present)

### 3. Yasushi Kitagawa

September 2007 Joined the Company  
 November 2007 Deputy General Manager of Manufacturing Division  
 April 2008 Deputy General Manager of Manufacturing Division and Quality Assurance Department  
 April 2009 Executive Officer, Deputy General Manager of Manufacturing Division and Quality Assurance Department  
 August 2009 Executive Officer, General Manager of Manufacturing Division and Quality Assurance Department  
 June 2010 Director and General Manager of Manufacturing Division and Quality Assurance Department  
 June 2013 Managing Director and General Manager of Manufacturing Division and Quality Assurance Department  
 June 2017 Executive Managing Director and General Manager of Manufacturing Division and Quality Assurance Department (To the present)

### 4. Tomohiro Inano

June 1989 Joined the Company  
 August 2003 General Manager of Yushin Precision Equipment Trading (Shenzhen) Co., Ltd.  
 April 2008 General Manager of Chinese Area and Yushin Precision Equipment Trading (Shenzhen) Co., Ltd.  
 July 2009 Assistant to General Manager of Sales Division  
 February 2010 Deputy General Manager of Sales Division  
 March 2011 General Manager of Sales Division  
 March 2014 Executive Officer and General Manager of Sales Division  
 June 2017 Director and General Manager of Sales Division (To the present)

### 5. Yasuo Nishiguchi

March 1975 Joined Kyoto Ceramic Co., Ltd. (currently Kyocera Corporation)  
 June 1987 Director  
 June 1992 Senior Managing Director and Representative Director  
 June 1997 Executive Vice president and Representative Director  
 June 1999 President and Representative Director  
 June 2003 President and Representative Director and President and Executive Officer

June 2005 Chairman of the Board and Representative Director, and Chief Executive Officer  
 April 2006 Advisor and Director  
 June 2009 Retired from the office of Director  
 June 2014 External Director of the Company (To the present)  
 March 2015 Chairman and CEO of Socionext Inc.  
 June 2016 External Director of YAMADA Consulting Group Co., Ltd. (To the present)  
 March 2018 Retired from Chairman and CEO of Socionext Inc.

### 6. Hiroshi Matsuhisa

June 1976 Research Assistant of school of precision engineering in Faculty of Engineering at Kyoto University  
 October 1987 Assistant professor  
 April 1994 Professor (transferred to graduate school of department of Mechanical Engineering and Science by a reorganization in 1995)  
 April 2012 Professor emeritus at Kyoto University  
 June 2014 External Director of the Company (To the present)  
 June 2016 External Corporate Auditor of Technology Seed Incubation Co., Ltd.  
 June 2018 Retired from External Corporate Auditor of Technology Seed Incubation Co., Ltd.

### 7. Reiko Nakayama

April 1983 Joined Japan Associated Finance Co., Ltd. (currently JAFCO Co., Ltd)  
 January 1997 Joined Marusan Securities Co., Ltd.  
 March 2000 General Manager of Investment information  
 October 2004 General Manager of Underwriting  
 October 2008 Part-time Director of LivTech, Inc.  
 February 2009 Director and Head of Administrative H.Q. of LivTech, Inc.  
 March 2013 Retired from the office of Director of LivTech, Inc.  
 March 2015 External Director of LUCKLAND CO.,LTD  
 March 2016 Director of LUCKLAND CO.,LTD (Audits Committee) (To the present)  
 June 2018 External Director of the Company (To the present)  
 June 2019 External Director of Mandam Corporation (To the present)

# Messages from New Officers

## ● Auditors

### 8. Yoshihisa Nakanishi

March 2008 Joined the Company  
April 2008 General Manager of Personnel Affairs Section  
June 2008 General Manager of Accounting Department  
July 2015 General Manager of Internal Audit Office  
July 2017 Corporate Auditor of the Company  
(To the present)

### 9. Hiroho Kamakura

November 1971 Joined Tohmatsu Aoki & Co.  
(currently "Deloitte Touche Tohmatsu LLC" )  
May 1973 Registered as CPA  
July 2012 External Corporate Auditor of  
Trusco Nakayama Corporation  
(To the present)  
July 2012 External Corporate Auditor of the Company  
(To the present)  
March 2013 External Corporate Auditor of  
FUJIO FOOD SYSTEM CO., LTD.  
(To the present)

### 10. Michitoshi Morimoto

April 1981 Joined FUJITEC Co., Ltd.  
February 1982 Joined Osaka Research Institute of  
Industrial Science and Technology  
February 1987 Joined Matsushita Electric Industrial Co., Ltd.  
(Panasonic Corporation)  
October 1990 Joined Nomura Research Institute, Ltd.  
January 2016 Joined Human Holdings Co., Ltd.  
Executive officer (CIO)  
November 2016 Retired from the Human Holdings Co., Ltd.  
July 2017 External Corporate Auditor of the Company  
(To the present)

## ● Officer

### 11. Masahito Fukui

October 2013 Joined the Company as General Manager of  
Internal Audit Office  
July 2015 General Manager of Accounting Department  
July 2017 Executive Officer and  
General Manager of Accounting Department  
(To the present)

### 12. Takayo Kotani

April 2008 Joined the Company  
October 2008 Manager of R&D Section  
April 2009 General Manager of R&D Department  
April 2019 Executive Officer and  
General Manager of R&D Department  
June 2019 Executive Officer and  
General Manager of R&D Division  
(To the present)

### 13. Naoki Tsuji

September 2015 Joined the Company  
May 2016 Manager of Product Planning and  
Marketing Development Office  
April 2019 Executive Officer and  
General Manager of Product Planning and  
Marketing Development Department  
(To the present)

### 14. Kota Oda

October 2015 Joined the Company as General Manager of  
General Affairs Department  
April 2019 Executive Officer and  
General Manager of General Affairs  
Department  
(To the present)

## Takayo Kotani, Dr.Eng. - <R&D Division>

I want to deliver a product that makes our customers at manufacturing plants around the world say "Wow, thank goodness for YUSHIN!" and I will be devoting all my energy into the research & development necessary for that aim. My plan is to contribute to YUSHIN's continuous growth by mastering new technology each day, thinking adaptably while setting R&D targets, and completing all tasks with careful attention to detail.



## Naoki Tsuji - <Product Planning Dept.>

To help bring about sustainable growth for the company, I will strive to improve our product and staff and promote the YUSHIN brand in different ways. Further, I want to strengthen YUSHIN's brand value so that the entire YUSHIN group benefits. Currently, I'm helping customers improve their molding operations with INTU LINE, YUSHIN's IoT service. I am working hard to make INTU LINE an intelligent ecosystem upon which the modern plastics industry can build.



## Kota Oda - <General Affairs>

YUSHIN will celebrate the 50th anniversary of its founding in 2023. To grow our business even further and accomplish breakthroughs beyond, it is important to learn wisdom and experiences of our foremen in the company's history. Also, for the purpose of sustainable growth, it is vital to build capabilities through organizational change and to improve the ability of the organization's people.

I would like to contribute to create an environment where our members can collaborate actively and work productively with a feeling of greater enrichment.



# A Conversation between Directors

President Kotani and External Director Nishiguchi discuss YUSHIN's opportunities, strengths, growth and governance.



**Yasuo Nishiguchi**  
<External Director>

## ● About YUSHIN's Strengths and Growth Opportunities

**Nishiguchi :** YUSHIN's core business is providing stable and high-speed take-out of injection-molded parts to manufacturers in a diverse range of industries like electronics, medical goods, and food packaging. That diversity is one of our strengths.

**Kotani :** The automotive industry is one of our main customers, but as automakers develop more electric vehicles, weight reduction will grow in importance and most components will become plastic. That should mean more opportunities for us in the plastics industry.

**Nishiguchi :** I believe that there will be plenty of room for growth as the field of take-out robots follows market changes. Furthermore, if we look beyond just take-out of injection molded parts, I think there is potential for growth in part-handling in general, of various types of products. And incorporating AI into take-out robots will expand the possibilities even further.

## ● About YUSHIN's Growth

**Nishiguchi :** YUSHIN has launched a project to strengthen collaboration among departments. Our goal is to strengthen company management by deepening discussions across departmental lines. I expect the improved dialogue will benefit the entire YUSHIN organization.

## ● About YUSHIN's Governance

**Kotani :** Over the years, the number of external directors has increased, the company's scope has grown, and people inside the company have changed, too. Currently, our Board includes 3 external directors and 2 external corporate auditors. It's a diverse group that includes large company presidents like you, Mr. Nishiguchi, along with mechanical engineers, institutional investors, CPAs, and IT professionals. It's a well-informed body and discussions are always lively and productive.

**Nishiguchi :** Over a period of several years we have been carrying out a corporate goal of increasing YUSHIN's scale and the quality of management. I think that as this growth is happening, we have been developing the appropriate corporate governance.

**Kotani :** And I expect the addition of young new executive officers this fiscal year will further invigorate the company.



**Mayumi Kotani**  
<President and Representative Director>

## <Contents>

Consolidated Balance Sheet .....	21
Consolidated Statement of Income .....	23
Consolidated Statement of Comprehensive Income .....	23
Consolidated Statement of Changes in Equity .....	24
Consolidated Statement of Cash Flows .....	25
Notes to Consolidated Financial Statements .....	26
Independent Auditor's Report .....	38
Company Profile .....	39
Major Shareholders .....	39

# Consolidated Balance Sheet

YUSHIN PRECISION EQUIPMENT CO., LTD. and Subsidiaries  
March 31, 2019

ASSETS	Millions of Yen		Thousands of U.S. Dollars (Note 1)
	2019	2018	2019
<b>CURRENT ASSETS:</b>			
Cash and cash equivalents (Note 9) .....	¥ 4,669	¥ 3,763	\$ 42,063
Short-term investments (Note 9) .....	1,693	1,891	15,260
Receivables (Note 9) :			
Trade notes .....	1,824	1,866	16,436
Trade accounts .....	5,020	5,176	45,227
Allowance for doubtful receivables .....	(18)	(20)	(165)
Inventories (Note 4) .....	6,033	5,485	54,354
Other current assets .....	742	764	6,686
Total current assets .....	19,964	18,927	179,863
<b>PROPERTY, PLANT AND EQUIPMENT:</b>			
Land .....	6,130	6,133	55,231
Buildings and structures .....	8,899	8,794	80,172
Machinery and equipment .....	572	561	5,154
Furniture and fixtures .....	1,537	1,511	13,851
Construction in progress .....	8	4	77
Total .....	17,148	17,006	154,487
Accumulated depreciation .....	(5,739)	(5,122)	(51,708)
Net property, plant and equipment .....	11,408	11,883	102,778
<b>INVESTMENTS AND OTHER ASSETS:</b>			
Investment securities (Notes 3 and 9) .....	218	276	1,964
Insurance funds .....	143	131	1,294
Asset for retirement benefits (Note 5) .....	294	274	2,648
Deferred tax assets (Note 7) .....	705	574	6,354
Other assets .....	462	504	4,169
Total investments and other assets .....	1,823	1,761	16,431
<b>TOTAL</b> .....	¥ 33,197	¥ 32,572	\$ 299,074

See notes to consolidated financial statements.

LIABILITIES AND EQUITY	Millions of Yen		Thousands of U.S. Dollars (Note 1)
	2019	2018	2019
<b>CURRENT LIABILITIES:</b>			
Payables (Note 9) :			
Trade notes .....	¥ 92	¥ 58	\$ 835
Trade accounts .....	2,274	2,847	20,491
Construction and other .....	492	505	4,434
Advances from customers .....	1,755	1,175	15,815
Income taxes payable (Note 9) .....	523	608	4,719
Accrued expenses .....	505	485	4,557
Warranty reserve .....	147	145	1,329
Other current liabilities (Note 7) .....	67	71	610
Total current liabilities .....	5,860	5,897	52,793
<b>LONG-TERM LIABILITIES:</b>			
Liability for retirement benefits to directors (Note 5) .....	66	66	601
Liability for retirement benefits (Note 5) .....	65	51	592
Deferred tax liabilities (Note 7) .....	37	32	336
Other .....	49	52	449
Total long-term liabilities .....	219	203	1,979
<b>EQUITY (Notes 2.o. and 6):</b>			
Common stock - authorized, 80,000,000 shares; issued, 35,638,066 shares in 2019 and 2018* .....	1,985	1,985	17,888
Capital surplus .....	2,023	2,023	18,233
Retained earnings .....	23,579	22,270	212,426
Treasury stock - at cost, 1,333,548 shares in 2019 and 663,964 shares in 2018* .....	(1,039)	(354)	(9,360)
Accumulated other comprehensive income:			
Unrealized gains on available-for-sale securities .....	56	97	511
Foreign currency translation adjustments .....	184	164	1,665
Defined retirement benefit plan .....	69	56	628
Total .....	26,861	26,243	241,994
Noncontrolling interests .....	256	228	2,306
Total equity .....	27,117	26,472	244,301
<b>TOTAL</b> .....	¥ 33,197	¥ 32,572	\$ 299,074

\* Shares have been restated, as appropriate, to reflect a two-for-one stock split effected April 1, 2018.  
See notes to consolidated financial statements.

# Consolidated Statement of Income

YUSHIN PRECISION EQUIPMENT CO., LTD. and Subsidiaries  
Year Ended March 31, 2019

	Millions of Yen		Thousands of U.S. Dollars (Note 1)
	2019	2018	2019
<b>NET SALES</b> .....	¥ 21,833	¥ 20,878	\$ 196,697
<b>COST OF SALES</b> .....	13,092	12,417	117,947
Gross profit .....	8,741	8,461	78,749
<b>SELLING, GENERAL AND ADMINISTRATIVE EXPENSES (Note 8)</b> .....	5,980	6,102	53,877
Operating income .....	2,760	2,358	24,872
<b>OTHER INCOME (EXPENSES):</b>			
Interest and dividend income .....	10	10	94
Foreign exchange loss .....	(77)	(54)	(697)
Other-net .....	89	123	808
Other income (expenses) - net .....	22	79	205
<b>INCOME BEFORE INCOME TAXES</b> .....	2,783	2,438	25,077
<b>INCOME TAXES (Note 7):</b>			
Current .....	930	896	8,381
Deferred .....	(110)	(141)	(995)
Total income taxes .....	819	755	7,385
<b>NET INCOME</b> .....	1,963	1,682	17,692
<b>NET INCOME ATTRIBUTABLE TO NONCONTROLLING INTERESTS</b> .....	60	56	544
<b>NET INCOME ATTRIBUTABLE TO OWNERS OF THE PARENT</b> .....	¥ 1,903	¥ 1,626	\$ 17,148
	Yen		U.S. Dollars (Note 1)
<b>PER SHARE OF COMMON STOCK (Notes 2.o. and 11):</b>			
Net income* .....	¥ 54.54	¥ 46.51	\$ 0.49
Cash dividends applicable to the year* .....	17.00	33.00	0.15

\*Net income has been restated, as appropriate, to reflect a two-for-one stock split effected April 1, 2018.  
Dividends per share have not been restated to reflect the two-for-one stock split.  
See notes to consolidated financial statements.

# Consolidated Statement of Comprehensive Income

YUSHIN PRECISION EQUIPMENT CO., LTD. and Subsidiaries  
Year Ended March 31, 2019

	Millions of Yen		Thousands of U.S. Dollars (Note 1)
	2019	2018	2019
<b>NET INCOME</b> .....	¥ 1,963	¥ 1,682	\$ 17,692
<b>OTHER COMPREHENSIVE INCOME (LOSS) (Note 10) :</b>			
Unrealized (losses) gains on available-for-sale securities .....	(40)	38	(362)
Foreign currency translation adjustments .....	26	(31)	234
Defined retirement benefit plan .....	12	(10)	114
Total other comprehensive loss .....	(1)	(3)	(13)
<b>COMPREHENSIVE INCOME</b> .....	¥ 1,962	¥ 1,679	\$ 17,678
<b>TOTAL COMPREHENSIVE INCOME ATTRIBUTABLE TO :</b>			
Owners of the parent .....	¥ 1,896	¥ 1,615	\$ 17,085
Noncontrolling interests .....	65	64	593

See notes to consolidated financial statements.

# Consolidated Statement of Changes in Equity

YUSHIN PRECISION EQUIPMENT CO., LTD. and Subsidiaries  
Year Ended March 31, 2019

	Thousands		Millions of Yen							Total	Noncontrolling Interests	Total Equity
	Outstanding Number of Shares of Common Stock* (Note 12)	Common Stock	Capital Surplus	Retained Earnings	Treasury Stock	Unrealized Gains on Available-for- Sale Securities	Foreign Currency Translation Adjustments	Defined Retirement Benefit Plan				
<b>BALANCE, APRIL 1, 2017</b> .....	34,975	¥ 1,985	¥ 2,023	¥ 21,273	¥ (353)	¥ 58	¥ 203	¥ 67	¥ 25,258	¥ 193	¥ 25,451	
Net income .....				1,626					1,626		1,626	
Cash dividends, ¥ 36 per share* ..				(629)					(629)		(629)	
Purchase of treasury stock .....	(0)				(0)				(0)		(0)	
Net change in the year .....						38	(38)	(10)	(11)	35	23	
<b>BALANCE, MARCH 31, 2018</b> .....	34,974	1,985	2,023	22,270	(354)	97	164	56	26,243	228	26,472	
Net income .....				1,903					1,903		1,903	
Cash dividends, ¥ 17 per share* ..				(594)					(594)		(594)	
Purchase of treasury stock .....	(669)				(684)				(684)		(684)	
Net change in the year .....						(40)	20	12	(6)	27	20	
<b>BALANCE, MARCH 31, 2019</b> .....	34,304	¥ 1,985	¥ 2,023	¥ 23,579	¥ (1,039)	¥ 56	¥ 184	¥ 69	¥ 26,861	¥ 256	¥ 27,117	

	Thousands of U.S. Dollars (Note 1)		Millions of Yen							Total	Noncontrolling Interests	Total Equity
	Common Stock	Capital Surplus	Retained Earnings	Treasury Stock	Unrealized Gains on Available-for- Sale Securities	Foreign Currency Translation Adjustments	Defined Retirement Benefit Plan					
<b>BALANCE, MARCH 31, 2018</b> .....	\$ 17,888	\$ 18,233	\$ 200,635	\$ (3,196)	\$ 874	\$ 1,480	\$ 513	\$ 236,429	\$ 2,057	\$ 238,486		
Net income .....			17,148					17,148		17,148		
Cash dividends, \$0.15 per share* ..			(5,356)					(5,356)		(5,356)		
Purchase of treasury stock .....				(6,163)				(6,163)		(6,163)		
Net change in the year .....					(362)	185	114	(62)	249	186		
<b>BALANCE, MARCH 31, 2019</b> .....	\$ 17,888	\$ 18,233	\$ 212,426	\$ (9,360)	\$ 511	\$ 1,665	\$ 628	\$ 241,994	\$ 2,306	\$ 244,301		

\* Shares have been restated, as appropriate, to reflect a two-for-one stock split effected April 1, 2018.  
Dividends per share have not been restated to reflect the two-for-one stock split.  
See notes to consolidated financial statements.

# Consolidated Statement of Cash Flows

YUSHIN PRECISION EQUIPMENT CO., LTD. and Subsidiaries  
Years Ended March 31, 2019

	Millions of Yen		Thousands of U.S. Dollars (Note 1)
	2019	2018	2019
<b>OPERATING ACTIVITIES:</b>			
Income before income taxes .....	¥ 2,783	¥ 2,438	\$ 25,077
Adjustments for:			
Income taxes - paid .....	(933)	(402)	(8,412)
Depreciation and amortization .....	782	935	7,048
Increase (decrease) in provision for doubtful receivables ..	(1)	19	(15)
Changes in assets and liabilities:			
Decrease (Increase) in trade receivables .....	175	(536)	1,578
Increase in inventories .....	(540)	(1,661)	(4,866)
Decrease in trade payables .....	(518)	(111)	(4,673)
Other - net .....	544	542	4,905
Total adjustments .....	(492)	(1,214)	(4,435)
Net cash provided by operating activities .....	2,291	1,223	20,642
<b>INVESTING ACTIVITIES:</b>			
Increase in short-term investments .....	(1,653)	(1,846)	(14,893)
Decrease in short-term investments .....	1,850		16,666
Purchases of property, plant and equipment .....	(193)	(572)	(1,741)
Proceeds from sales of property, plant and equipment .....	8	53	77
Purchases of investment securities .....	(0)	(0)	(0)
Other - net .....	(73)	(147)	(666)
Net cash used in investing activities .....	(61)	(2,511)	(556)
<b>FINANCING ACTIVITIES:</b>			
Dividends paid .....	(594)	(629)	(5,355)
Dividends paid to noncontrolling interests .....	(38)	(28)	(343)
Purchase of treasury stock .....	(684)	(0)	(6,163)
Net cash used in financing activities .....	(1,316)	(659)	(11,862)
<b>EFFECT OF EXCHANGE RATE CHANGES ON CASH AND CASH EQUIVALENTS .....</b>	<b>(7)</b>	<b>20</b>	<b>(63)</b>
<b>NET INCREASE (DECREASE) IN CASH AND CASH EQUIVALENTS .....</b>	<b>905</b>	<b>(1,927)</b>	<b>8,159</b>
<b>CASH AND CASH EQUIVALENTS, BEGINNING OF YEAR .....</b>	<b>3,763</b>	<b>5,690</b>	<b>33,903</b>
<b>CASH AND CASH EQUIVALENTS, END OF YEAR .....</b>	<b>¥ 4,669</b>	<b>¥ 3,763</b>	<b>\$ 42,063</b>

See notes to consolidated financial statements.

# Notes to Consolidated Financial Statements

YUSHIN PRECISION EQUIPMENT CO., LTD. and Subsidiaries  
Years Ended March 31, 2019

## 1. BASIS OF PRESENTATION OF CONSOLIDATED FINANCIAL STATEMENTS

The accompanying consolidated financial statements have been prepared in accordance with the provisions set forth in the Japanese Financial Instruments and Exchange Act and its related accounting regulations and in accordance with accounting principles generally accepted in Japan ("Japanese GAAP"), which are different in certain respects as to the application and disclosure requirements of International Financial Reporting Standards.

In preparing these consolidated financial statements, certain reclassifications and rearrangements have been made to the consolidated financial statements issued domestically in order to present them in a form which is more familiar to readers outside Japan. In addition, certain reclassifications have been made in the 2018 consolidated financial statements to conform to the classifications used in 2019.

The fiscal year-end dates of all consolidated subsidiaries except for Yushin Precision Equipment (India) Pvt. Ltd. are different from that of the

consolidated balance sheet date of March 31. They are dated December 31, and the financial statements of these subsidiaries as of the provisional closing date of March 31 are used for consolidation purposes.

The consolidated financial statements are stated in Japanese yen, the currency of the country in which Yushin Precision Equipment Co., Ltd. (the "Company") is incorporated and operates. The translations of Japanese yen amounts into U.S. dollar amounts are included solely for the convenience of readers outside Japan and have been made at the rate of ¥111 to \$1, the approximate rate of exchange at March 31, 2019. Such translations should not be construed as representations that the Japanese yen amounts could be converted into U.S. dollars at that or any other rate.

Amounts less than one million yen and one thousand U.S. dollars are rounded down, except for per-share data. Therefore, total or subtotal amounts may not correspond with the aggregation of such account balances.

## 2. SUMMARY OF SIGNIFICANT ACCOUNTING POLICIES

**a. Consolidation** - The consolidated financial statements as of March 31, 2019, include the accounts of the Company and all of its subsidiaries (together, the "Group").

Under the control concept, those companies in which the Company is able to directly exercise control over operations are fully consolidated.

All significant intercompany balances and transactions have been eliminated in consolidation. All material unrealized profit included in assets resulting from transactions within the Group is also eliminated.

**b. Unification of Accounting Policies Applied to Foreign Subsidiaries for the Consolidated Financial Statements** - Under Accounting Standards Board of Japan ("ASBJ") Practical Issues Task Force ("PITF") No. 18, "Practical Solution on Unification of Accounting Policies Applied to Foreign Subsidiaries for the Consolidated Financial Statements," the accounting policies and procedures applied to a parent company and its subsidiaries for similar transactions and events under similar circumstances should in principle be unified for the preparation of the consolidated financial statements. However, financial statements prepared by foreign subsidiaries in accordance with either International Financial Reporting Standards or generally accepted accounting principles in the United States of America (Financial Accounting Standards Board Accounting Standards Codification) tentatively may be used for the consolidation process, except for the following items, which should be adjusted in the consolidation process so that net income is accounted for in accordance with Japanese GAAP, unless they are not material: (a) amortization of goodwill; (b) scheduled amortization of actuarial gain or loss on pensions that has been recorded in equity through other comprehensive income; (c) expensing capitalized development costs of R&D; and (d) cancellation of the fair value model of accounting for property, plant and equipment and investment properties and incorporation of the cost model of accounting.

**c. Cash Equivalents** - Cash equivalents are short-term investments that are readily convertible into cash and exposed to insignificant risk of changes in value. Cash equivalents include time deposits which mature or become due within three months of the date of acquisition.

**d. Inventories** - Inventories are principally stated at the lower of cost, determined by the specific identification method for finished products and work in process, and by the average method for raw materials and supplies, or net selling value.

**e. Securities** - Securities are investment securities in the consolidated balance sheet. All investment securities are classified as

available-for-sale securities, which are not classified as either trading securities or held-to-maturity debt securities, and are reported at fair value, with unrealized gains and losses, net of applicable taxes, reported in a separate component of equity. The cost of securities sold is determined based on the moving-average method. For other-than-temporary declines in fair value, investment securities are reduced to net realizable value by a charge to income.

**f. Property, Plant and Equipment** - Property, plant and equipment are stated at cost. Depreciation of property, plant and equipment of the Group is principally computed by the declining-balance method at rates based on the estimated useful lives of the assets. The range of useful lives is principally from 13 to 40 years for buildings and structures and from 5 to 12 years for machinery and equipment.

**g. Long-Lived Assets** - The Group reviews its long-lived assets for impairment whenever events or changes in circumstance indicate the carrying amount of an asset or asset group may not be recoverable. An impairment loss is recognized if the carrying amount of an asset or asset group exceeds the sum of the undiscounted future cash flows expected to result from the continued use and eventual disposition of the asset or asset group. The impairment loss would be measured as the amount by which the carrying amount of the asset exceeds its recoverable amount, which is the higher of the discounted cash flows from the continued use and eventual disposition of the asset or the net selling price at disposition.

**h. Warranty Reserve** - In order to provide for future warranty expenses for the Group's products, a warranty reserve is estimated and recorded principally on the basis of the Company's historical experience.

**i. Retirement Benefits** - The Company has a funded defined benefit pension plan and a funded defined contribution pension plan covering substantially all of its employees. Certain subsidiaries have an unfunded defined benefit plan or an unfunded defined contribution plan.

The Company accounts for the liability for retirement benefits based on the projected benefit obligations and plan assets at the balance sheet date. The projected benefit obligations are attributed to periods on a benefit formula basis. Actuarial gains and losses that are yet to be recognized in profit or loss are recognized within equity (accumulated other comprehensive income), after adjusting for tax effects and are recognized in profit or loss over 10 to 16 years, no longer than the expected average remaining service period of the employees. The discount rate is determined using a single weighted-average discount rate reflecting the estimated timing and amount of benefit payment.

Retirement benefits to directors are provided at the estimated amount which would be required if all directors retired at the balance sheet date.

The Company terminated its retirement benefit plan for directors on June 29, 2006, and no additional provisions have been recorded since then. As of March 31, 2019 and 2018, the balance of the liability for retirement benefits to directors was ¥66 million (\$601 thousand), and ¥66 million provided in proportion to the term that present directors had been in place before June 29, 2006.

**j. Research and Development Costs** - Research and development costs are charged to income as incurred.

**k. Bonuses to Directors** - Bonuses to directors are accrued at the year-end to which such bonuses are attributable.

**l. Income Taxes** - The provision for income taxes is computed based on the pretax income included in the consolidated statement of income. The asset and liability approach is used to recognize deferred tax assets and liabilities for the expected future tax consequences of temporary differences between the carrying amounts and the tax bases of assets and liabilities. Deferred taxes are measured by applying currently enacted income tax rates to the temporary differences.

On February 16, 2018, the ASBJ issued ASBJ Statement No. 28, "Partial Amendments to Accounting Standard for Tax Effect Accounting," which requires deferred tax assets and deferred tax liabilities to be classified as investments and other assets and long-term liabilities, respectively. Deferred tax assets were previously classified as current assets and investments and other assets, and deferred tax liabilities were previously classified as current liabilities and long-term liabilities under the previous accounting standard. The revised accounting standard is effective for annual periods beginning on or after April 1, 2018. The Company retrospectively applied the revised accounting standard effective April 1, 2018, and deferred tax assets of ¥436 million and deferred tax liabilities of ¥7 million which were previously classified as current assets and current liabilities, respectively, as of March 31, 2018, have been reclassified as investments and other assets and long-term liabilities, respectively, in the accompanying consolidated balance sheet.

**m. Foreign Currency Transactions** - All short-term and long-term monetary receivables and payables denominated in foreign currencies are translated into Japanese yen at the exchange rates at the balance sheet date. The foreign exchange gains and losses from translation are recognized in the consolidated statement of income to the extent that they are not hedged by forward exchange contracts.

**n. Foreign Currency Financial Statements** - The balance sheet accounts of the consolidated foreign subsidiaries are translated into Japanese yen at the current exchange rate as of the balance sheet date except for equity, which is translated at the historical rate. Differences arising from such translation are shown as "Foreign currency translation adjustments" under accumulated other comprehensive income in a separate component of equity. Revenue and expense accounts of consolidated foreign subsidiaries are translated into Japanese yen at the average exchange rate.

**o. Per-Share Information** - Basic net income per share is computed by dividing net income attributable to common shareholders by the weighted-average number of common shares outstanding for the period.

Diluted net income per share is not disclosed as there are no outstanding potentially dilutive securities.

Cash dividends per share presented in the accompanying consolidated statement of income are dividends applicable to the respective fiscal years, including dividends to be paid after the end of the year.

On April 1, 2018, the Company effected a two-for-one stock split based on the resolution of the Board of Directors meeting held on March 7, 2018. All prior year share and per share figures excluding dividends per share have been restated to reflect the impact of the stock split, and to provide data on a basis comparable to the year ended March 31, 2019. Such restatements include calculations regarding the Company's weighted-average number of common shares and basic net income per share.

**p. Accounting Changes and Error Corrections** - Under ASBJ Statement No. 24, "Accounting Standard for Accounting Changes and Error Corrections," and ASBJ Guidance No. 24, "Guidance on Accounting Standard for Accounting Changes and Error Corrections," accounting treatments are required as follows: (1) Changes in Accounting Policies – When a new accounting policy is applied following revision of an accounting standard, the new policy is applied retrospectively unless the revised accounting standard includes specific transitional provisions, in which case the entity shall comply with the specific transitional provisions. (2) Changes in Presentation – When the presentation of financial statements is changed, prior-period financial statements are reclassified in accordance with the new presentation. (3) Changes in Accounting Estimates – A change in an accounting estimate is accounted for in the period of the change if the change affects that period only, and is accounted for prospectively if the change affects both the period of the change and future periods. (4) Corrections of Prior-Period Errors – When an error in prior-period financial statements is discovered, those statements are restated.

**q. New Accounting Pronouncements** - On March 30, 2018, the ASBJ issued ASBJ Statement No. 29, "Accounting Standard for Revenue Recognition," and ASBJ Guidance No. 30, "Implementation Guidance on Accounting Standard for Revenue Recognition." The core principle of the standard and guidance is that an entity recognizes revenue to depict the transfer of promised goods or services to customers in an amount that reflects the consideration to which the entity expects to be entitled in exchange for those goods or services. An entity should recognize revenue in accordance with that core principle by applying the following steps:

- Step 1: Identify the contract(s) with a customer
- Step 2: Identify the performance obligations in the contract
- Step 3: Determine the transaction price
- Step 4: Allocate the transaction price to the performance obligations in the contract
- Step 5: Recognize revenue when (or as) the entity satisfies a performance obligation

The accounting standard and guidance are effective for annual periods beginning on or after April 1, 2021. Earlier application is permitted for annual periods beginning on or after April 1, 2018. The Company is in the process of determining the period from which the Company will apply the accounting standard and guidance. The Company is currently evaluating the effect that the adoption of the accounting standard and guidance will have on its consolidated financial statements.

### 3. SECURITIES

#### (1) Investment Securities

The costs and aggregate fair values of investment securities as of March 31, 2019 and 2018, were as follows:

	Millions of Yen							
	2019				2018			
Securities classified as:	Cost	Unrealized Gains	Unrealized Losses	Fair Value	Cost	Unrealized Gains	Unrealized Losses	Fair Value
Available-for-sale:								
Equity securities	¥ 136	¥ 81	¥ 0	¥ 218	¥ 136	¥ 139	¥ 0	¥ 276

	Thousands of U.S. Dollars			
	2019			
Securities classified as:	Cost	Unrealized Gains	Unrealized Losses	Fair Value
Available-for-sale:				
Equity securities	\$ 1,228	\$ 736	\$ 0	\$ 1,964

(2) Proceeds and realized gains on available-for-sale securities which were sold during the year ended March 31, 2019, were as follows:

	Millions of Yen	
	Proceeds	Realized Gains
Available-for-sale:		
Equity securities	¥ 0	¥ 0

For the year ended March 31, 2018, the proceeds, realized gains, and realized losses are not disclosed since there were no available-for-sale securities sold during the year ended March 31, 2018.

### 4. INVENTORIES

Inventories at March 31, 2019 and 2018, consisted of the following:

	Millions of Yen		Thousands of U.S. Dollars
	2019	2018	2019
Finished products	¥ 717	¥ 825	\$ 6,463
Work in process	1,696	1,117	15,280
Raw materials and supplies	3,619	3,542	32,611
Total	¥ 6,033	¥ 5,485	\$ 54,354

### 5. RETIREMENT AND PENSION PLANS

The Company has severance payment plans for employees. Under most circumstances, employees terminating their employment are entitled to retirement benefits determined based on the rate of pay at the time of termination, years of service, and certain other factors. Such retirement benefits are made in the form of a lump-sum severance payment or annuity payments from a trustee.

The Company has a funded defined benefit pension plan and a funded defined contribution pension plan for employees which cover approximately 50% each of their benefits. Certain subsidiaries have an unfunded defined benefit plan or an unfunded defined contribution plan.

(1) The changes in defined benefit obligations for the years ended March 31, 2019 and 2018, were as follows:

	Millions of Yen		Thousands of U.S. Dollars
	2019	2018	2019
Balance at beginning of year (as previously reported) ...	¥ 638	¥ 597	\$ 5,750
Current service cost .....	63	56	569
Interest cost .....	1	2	15
Actuarial losses (gains) .....	10	0	98
Benefits paid .....	(4)	(10)	(37)
Other .....	4	(6)	40
Balance at end of year .....	¥ 714	¥ 638	\$ 6,436

(2) The changes in plan assets for the years ended March 31, 2019 and 2018, were as follows:

	Millions of Yen		Thousands of U.S. Dollars
	2019	2018	2019
Balance at beginning of year .....	¥ 861	¥ 836	\$ 7,758
Expected return on plan assets .....	8	8	77
Actuarial gains (losses) .....	35	(16)	318
Contributions from the employer .....	41	40	377
Benefits paid .....	(4)	(7)	(37)
Balance at end of year .....	¥ 942	¥ 861	\$ 8,493

(3) Reconciliations between the liability recorded in the consolidated balance sheet and the balances of defined benefit obligations and plan assets as of March 31, 2019 and 2018, were as follows:

	Millions of Yen		Thousands of U.S. Dollars
	2019	2018	2019
Funded defined benefit obligations .....	¥ 648	¥ 586	\$ 5,844
Plan assets .....	(942)	(861)	(8,493)
Total .....	(294)	(274)	(2,648)
Unfunded defined benefit obligations .....	65	51	592
Net assets arising from defined benefit obligations .....	¥ (228)	¥ (222)	\$ (2,056)

	Millions of Yen		Thousands of U.S. Dollars
	2019	2018	2019
Liability for retirement benefits .....	¥ 65	¥ 51	\$ 592
Asset for retirement benefits .....	(294)	(274)	(2,648)
Net assets arising from defined benefit obligations .....	¥ (228)	¥ (222)	\$ (2,056)

(4) The components of net periodic benefit costs for the years ended March 31, 2019 and 2018, were as follows:

	Millions of Yen		Thousands of U.S. Dollars
	2019	2018	2019
Service cost .....	¥ 63	¥ 56	\$ 569
Interest cost .....	1	2	15
Expected return on plan assets .....	(8)	(8)	(77)
Recognized actuarial gains .....	6	(0)	54
Net periodic benefit costs .....	¥ 62	¥ 49	\$ 562

(5) Amounts recognized in other comprehensive income (before income tax effect) in respect of defined retirement benefit plan for the years ended March 31, 2019 and 2018, were as follows:

	Millions of Yen		Thousands of U.S. Dollars
	2019	2018	2019
Actuarial gains (losses) .....	¥ 18	¥ (15)	\$ 165

(6) Amounts recognized in accumulated other comprehensive income (before income tax effect) in respect of defined retirement benefit plan as of March 31, 2019 and 2018, were as follows:

	Millions of Yen		Thousands of U.S. Dollars
	2019	2018	2019
Unrecognized actuarial gains .....	¥ 100	¥ 81	\$ 904

(7) Plan assets

*a. Components of plan assets*

Plan assets as of March 31, 2019 and 2018, consisted of the following:

	2019	2018
Domestic debt investments .....	0.0 %	0.0 %
Domestic equity investments .....	17.3	16.9
Foreign debt investments .....	8.2	6.2
Foreign equity investments .....	28.4	23.1
General accounts .....	3.1	3.4
Others .....	43.0	50.4
Total .....	100.0 %	100.0 %

Others mainly consists of short-term funds and alternative.

*b. Method of determining the expected rate of return on plan assets*

The expected rate of return on plan assets is determined considering the long-term rates of return which are expected currently and in the future from the various components of the plan assets.

(8) Assumptions used for the years ended March 31, 2019 and 2018, were set forth as follows:

	2019	2018
Discount rate .....	0.2 %	0.3 %
Expected rate of return on plan assets .....	1.0 %	1.0 %

(9) Defined contribution plans

The contributions to the defined contribution pension plan of the Company and the defined contribution plan of certain subsidiary were ¥60 million (\$548 thousand) and ¥56 million for the years ended March 31, 2019 and 2018, respectively.

## 6. EQUITY

Japanese companies are subject to the Companies Act of Japan (the "Companies Act"). The significant provisions in the Companies Act that affect financial and accounting matters are summarized below:

**a. Dividends**

Under the Companies Act, companies can pay dividends at any time during the fiscal year in addition to the year-end dividend upon resolution at the shareholders' meeting. Additionally, for companies that meet certain criteria including (1) having a Board of Directors, (2) having independent auditors, (3) having an Audit & Supervisory Board, and (4) the term of service of the directors being prescribed as one year rather than the normal two-year term by its articles of incorporation, the Board of Directors may declare dividends (except for dividends-in-kind) at any time during the fiscal year if the company has prescribed so in its articles of incorporation. The Company meets all the above criteria and, accordingly, the Board of Directors may declare dividends (except for dividends-in-kind) at any time during the fiscal year.

The Companies Act permits companies to distribute dividends-in-kind (noncash assets) to shareholders subject to a certain limitation and additional requirements.

Semiannual interim dividends may also be paid once a year upon

resolution by the Board of Directors if the articles of incorporation of the company so stipulate. The Companies Act provides certain limitations on the amounts available for dividends or the purchase of treasury stock. The limitation is defined as the amount available for distribution to the shareholders, but the amount of net assets after dividends must be maintained at no less than ¥3 million.

**b. Increases/Decreases and Transfer of Common Stock, Reserve and Surplus**

The Companies Act requires that an amount equal to 10% of dividends must be appropriated as a legal reserve (a component of retained earnings) or as additional paid-in capital (a component of capital surplus) depending on the equity account charged upon the payment of such dividends until the aggregate amount of legal reserve and additional paid-in capital equals 25% of the common stock. Under the Companies Act, the total amount of additional paid-in capital and legal reserve may be reversed without limitation. The Companies Act also provides that common stock, legal reserve, additional paid-in capital, other capital surplus, and retained earnings can be transferred among the accounts within equity under certain conditions upon resolution of the shareholders.

**c. Treasury Stock and Treasury Stock Acquisition Rights**

The Companies Act also provides for companies to purchase treasury stock and dispose of such treasury stock by resolution of the Board of Directors.



The amount of treasury stock purchased cannot exceed the amount available for distribution to the shareholders, which is determined by a specific formula. Under the Companies Act, stock acquisition rights are presented as a separate component of equity. The Companies Act also provides that companies can purchase both treasury stock acquisition rights and treasury stock. Such treasury stock acquisition rights are

presented as a separate component of equity or deducted directly from stock acquisition rights. On April 1, 2018, the Company made a two-for-one stock split by way of a free share distribution based on the resolution of the Board of Directors meeting held on March 7, 2018.

## 7. INCOME TAXES

The Company is subject to Japanese national and local income taxes which, in the aggregate, resulted in a normal effective statutory tax rate of approximately 30.5% each for the years ended March 31, 2019 and 2018.

The tax effects of significant temporary differences which resulted in deferred tax assets and liabilities at March 31, 2019 and 2018, were as follows:

	Millions of Yen		Thousands of U.S. Dollars
	2019	2018	2019
Deferred tax assets:			
Inventories	¥ 340	¥ 270	\$ 3,063
Depreciation	255	194	2,304
Software	159	176	1,433
Enterprise tax payable	27	29	251
Accrued bonuses	83	78	755
Warranty reserve	26	25	234
Retirement benefits to directors	20	20	183
Other	70	67	633
Total	¥ 983	¥ 862	\$ 8,859
Deferred tax liabilities:			
Undistributed earnings of foreign subsidiaries	¥ 178	¥ 167	\$ 1,608
Asset for retirement benefits	59	58	532
Unrealized gains on available-for-sale securities	24	42	224
Defined retirement benefit plan	30	25	275
Other	22	26	199
Total	¥ 315	¥ 320	\$ 2,840
Net deferred tax assets	¥ 668	¥ 541	\$ 6,018

Deferred tax assets (liabilities) are included in the consolidated balance sheets as follows:

	Millions of Yen		Thousands of U.S. Dollars
	2019	2018	2019
Investments and other assets - Deferred tax assets	¥ 705	¥ 574	\$ 6,354
Long-term liabilities - Deferred tax liabilities	(37)	(32)	(336)
Net deferred tax assets	¥ 668	¥ 541	\$ 6,018

For the years ended March 31, 2019 and 2018, a reconciliation is not disclosed since the difference of the normal effective statutory tax rate and actual effective tax rate is less than 5.0% of the normal effective statutory tax rate.

## 8. RESEARCH AND DEVELOPMENT COSTS

Research and development costs charged to income were ¥413 million (\$3,722 thousand) and ¥598 million for the years ended March 31, 2019 and 2018, respectively.

## 9. FINANCIAL INSTRUMENTS AND RELATED DISCLOSURES

### (1) Group policy for Financial Instruments

The Group does not use financial instruments for speculative purposes based on its capital financing plan. Cash surpluses, if any, are invested in low-risk financial assets, including short-term time deposits. Funds on hand are used to fund ongoing operations. Derivatives are not used for speculative purposes, but to manage exposure to financial risks.

### (2) Nature and Extent of Risks Arising from Financial Instruments

Receivables, such as trade notes and trade accounts, are exposed to customer credit risk. Receivables in foreign currencies are exposed to the market risk of fluctuation in foreign currency exchange rates. Investment securities are exposed to the risk of market price fluctuations. Payment terms of payables, such as trade notes and trade accounts, are primarily less than four months. Payment terms of income taxes payable and payables – construction and other are primarily less than one year.

### (3) Risk Management for Financial Instruments

#### Credit risk management

Credit risk is the risk of economic loss arising from a counterparty's failure to repay or service debt according to the contractual terms. The Group manages its credit risk from receivables on the basis of internal guidelines, which include monitoring of payment terms and balances of major customers by each business administration department to identify the default risk of customers at an early stage. Investment securities are managed by monitoring market values and financial position of issuers on a regular basis.

### (4) Fair Value of Financial Instruments

	Millions of Yen			Thousands of U.S. Dollars		
	Carrying Amount	Fair Value	Unrealized Gains/Losses	Carrying Amount	Fair Value	Unrealized Gains/Losses
<b>March 31, 2019</b>						
Cash and cash equivalents	¥ 4,669	¥ 4,669		\$ 42,063	\$ 42,063	
Short-term investments	1,693	1,693		15,260	15,260	
Receivables	6,844	6,844		61,663	61,663	
Investment securities	218	218		1,964	1,964	
Total	¥ 13,425	¥ 13,425		\$ 120,952	\$ 120,952	
Payables	¥ 2,859	¥ 2,859		\$ 25,760	\$ 25,760	
Income taxes payable	523	523		4,719	4,719	
Total	¥ 3,383	¥ 3,383		\$ 30,480	\$ 30,480	

	Millions of Yen		
	Carrying Amount	Fair Value	Unrealized Gains/Losses
<b>March 31, 2018</b>			
Cash and cash equivalents	¥ 3,763	¥ 3,763	
Short-term investments	1,891	1,891	
Receivables	7,042	7,042	
Investment securities	276	276	
<b>Total</b>	<b>¥ 12,974</b>	<b>¥ 12,974</b>	
Payables	¥ 3,410	¥ 3,410	
Income taxes payable	608	608	
<b>Total</b>	<b>¥ 4,019</b>	<b>¥ 4,019</b>	

#### Cash and Cash Equivalents, Short-Term Investments, Receivables and Payables, and Income Taxes Payable

The carrying values of cash and cash equivalents, short-term investments, receivables and payables, and income taxes payable approximate fair value because of their short maturities.

#### Investment Securities

The fair values of investment securities are measured at the quoted market price of the stock exchange for the equity instruments. Fair value information for investment securities by classification is included in Note 3.

#### (5) Maturity Analysis for Financial Assets with Contractual Maturities

	Millions of Yen			
	Due in 1 Year or Less	Due after 1 Year through 5 Years	Due after 5 Years through 10 Years	Due after 10 Years
<b>March 31, 2019</b>				
Cash and cash equivalents	¥ 4,669			
Short-term investments	1,693			
Receivables	6,844			
<b>Total</b>	<b>¥ 13,207</b>			

	Millions of Yen			
	Due in 1 Year or Less	Due after 1 Year through 5 Years	Due after 5 Years through 10 Years	Due after 10 Years
<b>March 31, 2018</b>				
Cash and cash equivalents	¥ 3,763			
Short-term investments	1,891			
Receivables	7,042			
<b>Total</b>	<b>¥ 12,698</b>			

	Thousands of U.S. Dollars			
	Due in 1 Year or Less	Due after 1 Year through 5 Years	Due after 5 Years through 10 Years	Due after 10 Years
<b>March 31, 2019</b>				
Cash and cash equivalents	\$ 42,063			
Short-term investments	15,260			
Receivables	61,663			
<b>Total</b>	<b>\$ 118,987</b>			

## 10. OTHER COMPREHENSIVE INCOME (LOSS)

The components of other comprehensive income (loss) for the years ended March 31, 2019 and 2018, were as follows:

	Millions of Yen		Thousands of U.S. Dollars
	2019	2018	2019
Unrealized gains on available-for-sale securities:			
Amount arising during the year	¥ (58)	¥ 55	\$ (524)
Reclassification adjustments to profit or loss	0	0	2
Amount before income tax effect	(57)	55	(522)
Income tax effect	17	(16)	159
<b>Total</b>	<b>¥ (40)</b>	<b>¥ 38</b>	<b>\$ (362)</b>
Foreign currency translation adjustments:			
Adjustments arising during the year	¥ 26	¥ (31)	\$ 234
Amount before income tax effect	26	(31)	234
<b>Total</b>	<b>¥ 26</b>	<b>¥ (31)</b>	<b>\$ 234</b>
Defined retirement benefit plan:			
Adjustments arising during the year	¥ 24	(16)	\$ 220
Reclassification adjustments to profit or loss	(6)	0	(54)
Amount before income tax effect	18	(15)	165
Income tax effect	(5)	4	(50)
<b>Total</b>	<b>¥ 12</b>	<b>(10)</b>	<b>\$ 114</b>
<b>Total other comprehensive loss</b>	<b>¥ (1)</b>	<b>¥ (3)</b>	<b>\$ (13)</b>

## 11. NET INCOME PER SHARE

Details of the basic net income per share (EPS) for the years ended March 31, 2019 and 2018, were as follows:

	Millions of Yen	Thousands of Shares	Yen	U.S. Dollars
	Net Income	Weighted-Average Shares	EPS	
<b>Year Ended March 31, 2019:</b>				
Basic EPS				
Net income available to common shareholders	¥ 1,903	34,901	¥ 54.54	\$ 0.49
<b>Year Ended March 31, 2018:</b>				
Basic EPS				
Net income available to common shareholders	¥ 1,626	34,974	¥ 46.51	

Diluted net income per share is not disclosed as there are no outstanding potentially dilutive securities.

The Company implemented a two-for-one stock split on April 1, 2018. The Company calculated net asset value per share assuming that the Company implemented a stock split as of the consolidated fiscal year beginning April 1, 2017.

## 12. SUBSEQUENT EVENTS

### Appropriation of Retained Earnings

The following appropriation of retained earnings at March 31, 2019, was approved at the Company's Board of Directors meeting held on May 10, 2019:

	Millions of Yen	Thousands of U.S. Dollars
Year-end cash dividends, ¥9 (\$ 0.08) per share .....	<b>¥ 308</b>	<b>\$ 2,781</b>

### 13. SEGMENT INFORMATION

Under ASBJ Statement No. 17, "Accounting Standard for Disclosures about Segments of an Enterprise and Related Information" and ASBJ Guidance No. 20, "Guidance on Accounting Standard for Disclosures about Segments of an Enterprise and Related Information," an entity is required to report financial and descriptive information about its reportable segments. Reportable segments are operating segments or aggregations of operating segments that meet specified criteria. Operating segments are components of an entity about which separate financial information is available and for which such information is evaluated regularly by the chief operating decision maker in deciding how to allocate resources and in assessing performance. Generally, segment information is required to be reported on the same basis as is used internally for evaluating operating segment performance and deciding how to allocate resources to operating segments.

#### (1) Description of Reportable Segments

Segments used for financial reporting are the Company's constituent units for which separate financial information is available and for which the Board of Directors performs periodic studies for the purposes of determining the allocation of resources and evaluating performance.

The Company carries out the development, production, sales, and after-sales maintenance of take-out robots for injection-molded products and peripheral equipment, including labor-saving systems. In the domestic market, these operations are handled by the Company; overseas markets – U.S.A., Asia (South Korea, Taiwan, China, Indonesia, Vietnam, Malaysia, Thailand, and India) and Europe (UK) – are serviced by local subsidiaries, including Yushin America Inc. (U.S.A.), Yushin Korea Co., Ltd. (Asia), and Yushin Automation Limited (Europe). The local subsidiaries are independently managed units, with separately drafted strategies and activities.

Accordingly, the Company's operations, based on its production, sales, and after-sales maintenance setups, are geographically grouped into four reportable segments: Japan, Asia, Europe, and the U.S.A.

#### (2) Methods of Measurement for the Amounts of Sales, Profit (Loss), Assets, and Other Items for Each Reportable Segment

The accounting procedure for the reportable segments is described in Note 2, "Summary of significant accounting policies." Segment profit by reportable segment is calculated based on operating income. Intersegment sales and transfers are based on a realized market price basis.

#### (3) Information about Sales, Profit, Assets and Other Items is as Follows:

	Millions of Yen						
	<b>2019</b>						
	Reportable Segment					Reconciliations	Consolidated
	Japan	Asia	Europe	U.S.A.	Total		
Sales:							
Sales to external customers .....	<b>¥ 12,581</b>	<b>¥ 4,924</b>	<b>¥ 914</b>	<b>¥ 3,412</b>	<b>¥ 21,833</b>		<b>¥ 21,833</b>
Intersegment sales or transfers .....	<b>4,892</b>	<b>275</b>	<b>3</b>	<b>28</b>	<b>5,200</b>	<b>¥ (5,200)</b>	
Total .....	<b>¥ 17,474</b>	<b>¥ 5,200</b>	<b>¥ 917</b>	<b>¥ 3,441</b>	<b>¥ 27,033</b>	<b>¥ (5,200)</b>	<b>¥ 21,833</b>
Segment profit .....	<b>¥ 2,045</b>	<b>¥ 533</b>	<b>¥ 81</b>	<b>¥ 307</b>	<b>¥ 2,967</b>	<b>¥ (206)</b>	<b>¥ 2,760</b>
Segment assets .....	<b>22,684</b>	<b>3,987</b>	<b>2,051</b>	<b>2,159</b>	<b>30,883</b>	<b>2,313</b>	<b>33,197</b>
Other:							
Depreciation .....	<b>702</b>	<b>25</b>	<b>16</b>	<b>34</b>	<b>778</b>	<b>4</b>	<b>782</b>
Increase in property, plant and equipment and intangible assets .....	<b>210</b>	<b>20</b>	<b>18</b>	<b>7</b>	<b>256</b>		<b>256</b>

	Millions of Yen						
	<b>2018</b>						
	Reportable Segment					Reconciliations	Consolidated
	Japan	Asia	Europe	U.S.A.	Total		
Sales:							
Sales to external customers .....	<b>¥ 11,736</b>	<b>¥ 5,286</b>	<b>¥ 696</b>	<b>¥ 3,159</b>	<b>¥ 20,878</b>		<b>¥ 20,878</b>
Intersegment sales or transfers .....	<b>4,987</b>	<b>306</b>	<b>2</b>	<b>41</b>	<b>5,338</b>	<b>¥ (5,338)</b>	
Total .....	<b>¥ 16,724</b>	<b>¥ 5,593</b>	<b>¥ 698</b>	<b>¥ 3,200</b>	<b>¥ 26,216</b>	<b>¥ (5,338)</b>	<b>¥ 20,878</b>
Segment profit .....	<b>¥ 1,409</b>	<b>¥ 607</b>	<b>¥ 130</b>	<b>¥ 260</b>	<b>¥ 2,408</b>	<b>¥ (49)</b>	<b>¥ 2,358</b>
Segment assets .....	<b>23,310</b>	<b>4,327</b>	<b>1,552</b>	<b>2,172</b>	<b>31,363</b>	<b>1,209</b>	<b>32,572</b>
Other:							
Depreciation .....	<b>845</b>	<b>24</b>	<b>17</b>	<b>38</b>	<b>924</b>	<b>11</b>	<b>935</b>
Increase in property, plant and equipment and intangible assets .....	<b>612</b>	<b>15</b>	<b>4</b>	<b>19</b>	<b>652</b>		<b>652</b>

	Thousands of U.S. Dollars						
	<b>2019</b>						
	Reportable Segment					Reconciliations	Consolidated
	Japan	Asia	Europe	U.S.A.	Total		
Sales:							
Sales to external customers .....	<b>\$ 113,349</b>	<b>\$ 44,366</b>	<b>\$ 8,236</b>	<b>\$ 30,744</b>	<b>\$ 196,697</b>		<b>\$ 196,697</b>
Intersegment sales or transfers .....	<b>44,075</b>	<b>2,483</b>	<b>33</b>	<b>259</b>	<b>46,851</b>	<b>\$ (46,851)</b>	
Total .....	<b>\$ 157,425</b>	<b>\$ 46,849</b>	<b>\$ 8,269</b>	<b>\$ 31,003</b>	<b>\$ 243,549</b>	<b>\$ (46,851)</b>	<b>\$ 196,697</b>
Segment profit .....	<b>\$ 18,426</b>	<b>\$ 4,802</b>	<b>\$ 738</b>	<b>\$ 2,767</b>	<b>\$ 26,734</b>	<b>\$ (1,862)</b>	<b>\$ 24,872</b>
Segment assets .....	<b>204,363</b>	<b>35,927</b>	<b>18,486</b>	<b>19,455</b>	<b>278,232</b>	<b>20,841</b>	<b>299,074</b>
Other:							
Depreciation .....	<b>6,325</b>	<b>228</b>	<b>148</b>	<b>309</b>	<b>7,012</b>	<b>36</b>	<b>7,048</b>
Increase in property, plant and equipment and intangible assets .....	<b>1,900</b>	<b>181</b>	<b>162</b>	<b>66</b>	<b>2,310</b>		<b>2,310</b>

Note 1: Reconciliations for the year ended March 31, 2019, are as follows:

- Reconciliations to segment profit of ¥(206) million (\$ (1,862) thousand) include eliminations for intersegment transactions of ¥25 million (\$229 thousand) and inventory reconciliation of ¥(232) million (\$ (2,092) thousand).
- Reconciliations to segment assets of ¥2,313 million (\$20,841 thousand) include eliminations for intersegment transactions of ¥(2,774) million (\$ (24,992) thousand) and operating funds of surplus assets held by the Company (cash and deposits and others) of ¥5,087 million (\$45,834 thousand) and others.
- Reconciliations to depreciation of ¥4 million (\$36 thousand) include eliminations for equipment related to research and development activities that do not belong to the reportable segments.

Note 2: Segment profit is reconciled to be consistent with operating income shown in the consolidated statements of income.

#### (4) Information about Products and Services

	Millions of Yen			
	<b>2019</b>			
	Take-Out Robots	Custom-Ordered Equipment	Parts and Maintenance Services	Total
Sales to external customers .....	<b>¥ 15,512</b>	<b>¥ 2,880</b>	<b>¥ 3,440</b>	<b>¥ 21,833</b>

# Independent Auditor's Report

**Deloitte.**

Deloitte Touche Tohmatsu LLC  
Shijokarasuma FT Square  
20 Naginataboko-cho  
Karasuma-higashiru, Shijo-dori  
Shimogyo-ku, Kyoto 600-8008  
Japan  
Tel: +81 (75) 222 0181  
Fax: +81 (75) 231 2703  
www.deloitte.com/jp/en

## INDEPENDENT AUDITOR'S REPORT

To the Board of Directors of Yushin Precision Equipment Co., Ltd.:

We have audited the accompanying consolidated balance sheet of Yushin Precision Equipment Co., Ltd. and its subsidiaries as of March 31, 2019, and the related consolidated statements of income, comprehensive income, changes in equity, and cash flows for the year then ended, and a summary of significant accounting policies and other explanatory information, all expressed in Japanese yen.

### Management's Responsibility for the Consolidated Financial Statements

Management is responsible for the preparation and fair presentation of these consolidated financial statements in accordance with accounting principles generally accepted in Japan, and for such internal control as management determines is necessary to enable the preparation of consolidated financial statements that are free from material misstatement, whether due to fraud or error.

### Auditor's Responsibility

Our responsibility is to express an opinion on these consolidated financial statements based on our audit. We conducted our audit in accordance with auditing standards generally accepted in Japan. Those standards require that we plan and perform the audit to obtain reasonable assurance about whether the consolidated financial statements are free from material misstatement.

An audit involves performing procedures to obtain audit evidence about the amounts and disclosures in the consolidated financial statements. The procedures selected depend on the auditor's judgment, including the assessment of the risks of material misstatement of the consolidated financial statements, whether due to fraud or error. In making those risk assessments, the auditor considers internal control relevant to the entity's preparation and fair presentation of the consolidated financial statements in order to design audit procedures that are appropriate in the circumstances, but not for the purpose of expressing an opinion on the effectiveness of the entity's internal control. An audit also includes evaluating the appropriateness of accounting policies used and the reasonableness of accounting estimates made by management, as well as evaluating the overall presentation of the consolidated financial statements.

We believe that the audit evidence we have obtained is sufficient and appropriate to provide a basis for our audit opinion.

### Opinion

In our opinion, the consolidated financial statements referred to above present fairly, in all material respects, the consolidated financial position of Yushin Precision Equipment Co., Ltd. and its subsidiaries as of March 31, 2019, and the consolidated results of their operations and their cash flows for the year then ended in accordance with accounting principles generally accepted in Japan.

### Convenience Translation

Our audit also comprehended the translation of Japanese yen amounts into U.S. dollar amounts and, in our opinion, such translation has been made in accordance with the basis stated in Note 1 to the consolidated financial statements. Such U.S. dollar amounts are presented solely for the convenience of readers outside Japan.

*Deloitte Touche Tohmatsu LLC*

June 18, 2019

Member of  
Deloitte Touche Tohmatsu Limited

Millions of Yen				
2018				
	Take-Out Robots	Custom-Ordered Equipment	Parts and Maintenance Services	Total
Sales to external customers .....	¥ 15,449	¥ 2,204	¥ 3,223	¥ 20,878

Thousands of U.S. Dollars				
2019				
	Take-Out Robots	Custom-Ordered Equipment	Parts and Maintenance Services	Total
Sales to external customers .....	\$ 139,753	\$ 25,952	\$ 30,991	\$ 196,697

## (5) Information about Geographical Areas

### a. Sales

Millions of Yen						
2019						
Japan	China Taiwan	Other Asia	Europe	North America	Other	Total
¥ 9,304	¥ 2,816	¥ 4,876	¥ 939	¥ 3,233	¥ 663	¥ 21,833

Millions of Yen						
2018						
Japan	China Taiwan	Other Asia	Europe	North America	Other	Total
¥ 8,335	¥ 3,468	¥ 4,594	¥ 687	¥ 3,172	¥ 620	¥ 20,878

Thousands of U.S. Dollars						
2019						
Japan	China Taiwan	Other Asia	Europe	North America	Other	Total
\$ 83,826	\$ 25,370	\$ 43,931	\$ 8,464	\$ 29,130	\$ 5,973	\$ 196,697

Note: Sales are classified by country or region based on the location of customers.

### b. Property, plant and equipment

Information is omitted because property, plant and equipment in Japan accounted for over 90% of property, plant and equipment on the consolidated balance sheet.

## (6) Information about Major Customers

Information is omitted because there were no customers that accounted for 10% or more of total net sales recorded in the consolidated statement of income.

# Company Profile

(As of March 31, 2019)

Company Name : YUSHIN PRECISION EQUIPMENT CO., LTD.

Establishment : October 1973

Capital : 1,985 million yen

Head Office : 555 Kuzetonosiro-cho, Minami-ku, Kyoto, Japan 601-8205

Phone : +(81)75-933-9555 Fax : +(81)75-934-4033

Number of Employees : 683 (Including consolidated subsidiaries) and 412 (Yushin Precision Equipment Co., Ltd. only)

Listed Stock Exchange : First Section, Tokyo

Securities Identification Code : 6482

## Major Shareholders

(As of March 31, 2019)

	Number of Shares held (thousand)	Percentage of Shares held (%)
Yushin Industry Co., Ltd. ....	11,992	35.0
The Master Trust Bank of Japan, Ltd. (Trust Account) .....	2,499	7.3
The Nomura Trust and Banking Co., Ltd. (Trust Account 3071019) .....	1,549	4.5
The Master Trust Bank of Japan, Ltd. (Retail Trust Account 620021158) .....	1,549	4.5
The Kyoto Chuo Shinkin Bank, Ltd. ....	1,088	3.2
Mayumi Kotani .....	1,054	3.1
Japan Trustee Service Bank, Ltd. (Trust Accounts) .....	933	2.7
MUFG Bank, Ltd. ....	849	2.5
The Bank of Kyoto, Ltd. ....	704	2.1
SMBC Trust Bank Ltd. (Sumitomo Mitsui Banking Corporation, Retirement and severance benefit trust account) .....	684	2.0

Note: "Percentage of Shares held (%)" is calculated after deducting the number of treasury stock (1,333,548 shares).

### Distribution of ownership among shareholders

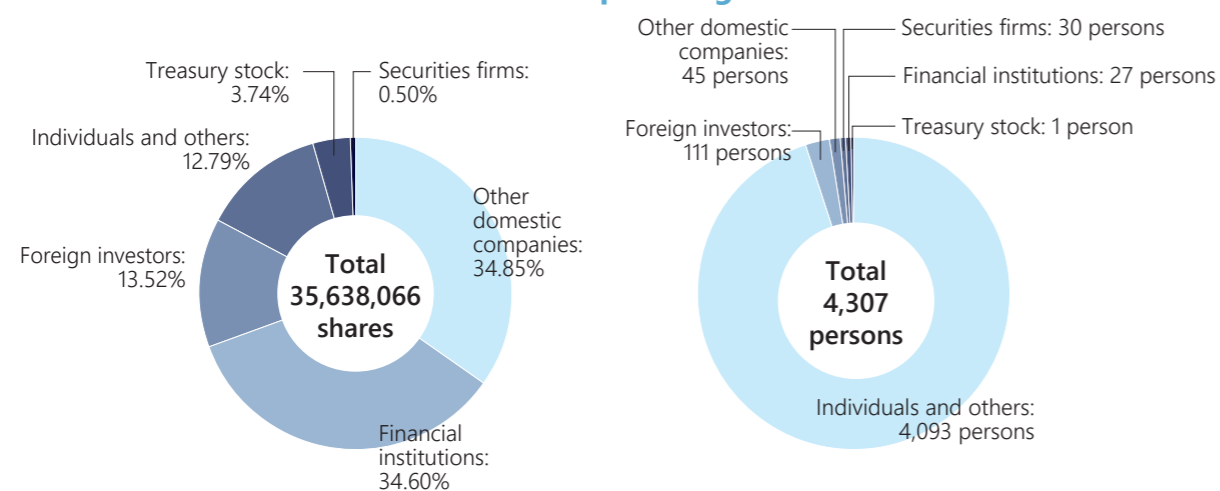

**YUSHIN PRECISION EQUIPMENT CO., LTD.**

555 Kuzetonoshiro-cho, Minami-ku, Kyoto

601-8205 JAPAN

<http://www.yushin.com>

